



High Performance Ruggedized Mobile NVRs

Customised Mobile Surveillance Built to Withstand Transportation Environments

IDIS Mobile NVR **DR-6308PM, DR-6316PSM**

- Durable anti-shock and anti-vibration design (MIL-STD-810 approved)
- Automatic data backup over WiFi
- 3-axis accelerometer for detecting emergency stop and start
- Integrated power supply protects data and internal circuitry
- Convenient installation with a single power cable

High Resolution Recording

These IDIS Mobile NVRs deliver the highest resolution and image quality available, without the noise common in other systems due to poor conditions in the vehicle.

- 480ips @ 4K UHD recording performance (for all 16 channels)
- H.265 and H.264 dual codec support
- 210Mbps of recording bandwidth supports dual simultaneous recording at two video quality levels for differing retention needs (for all 16 channels)



Automatic Data Backup and Long-term Recording

Automatic data backup over WiFi simplifies integration into a centralised monitoring environment. Dual track recording provides the ability to keep a high quality recording for a high profile incident and a second standard quality recording for longer data retention.

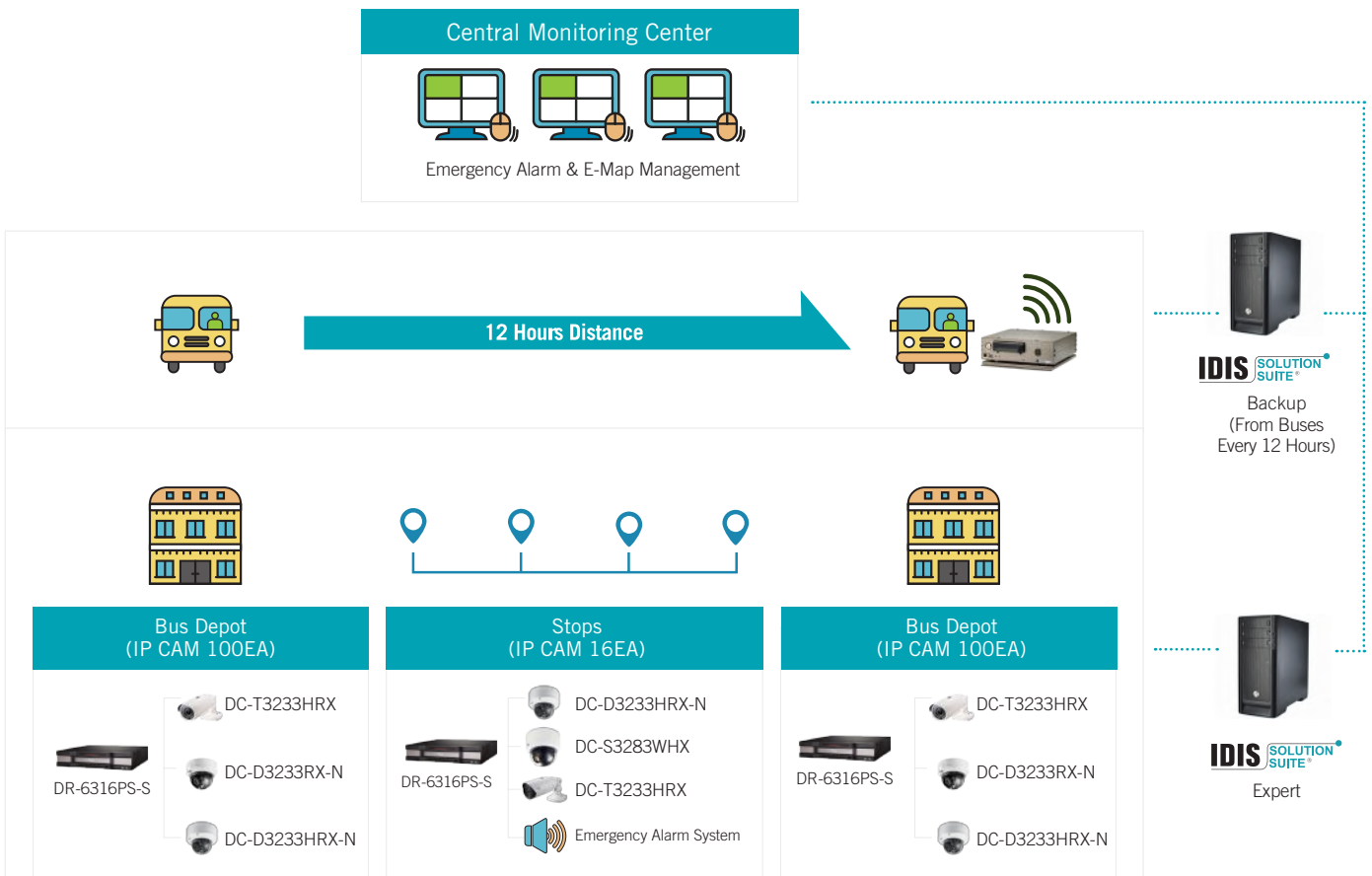

Single Power Connection

IDIS Mobile NVRs contain integrated power supplies that provide power for additional devices, DC 5V and 12V for alarms, RS-232/485 interface for external GPS integration, and PoE for all connected cameras. Just a single power connection is all that is needed to power the entire system.

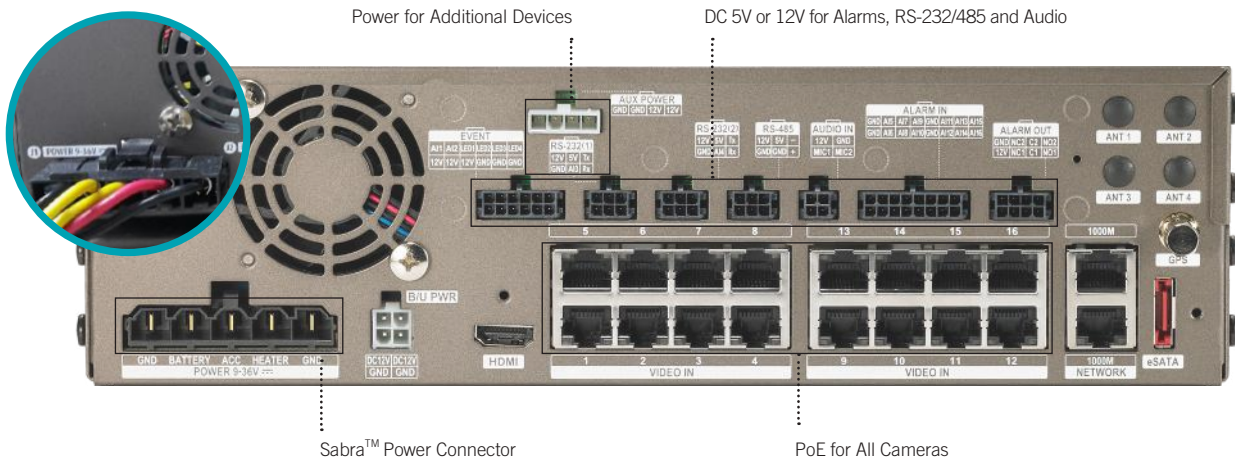

Complete Integrated Communications

IDIS Mobile NVRs combine all the necessary communication systems in a single box. With integrated WiFi and GPS systems, there is no need for an external modem or other devices.

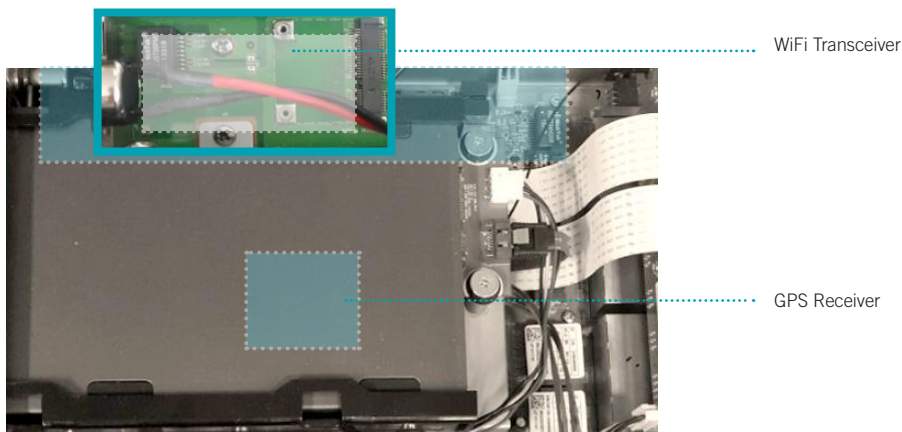

Isolated Power Block Design

The IDIS Mobile NVRs use an isolated power block design to minimise damage from external power issues and protect the recorded video. U.S. military certified (MIL-STD-810), an anti-shock and anti-vibration case further protects the system from the sometimes violent movements of the vehicle, reducing the likelihood of data loss or system outage.

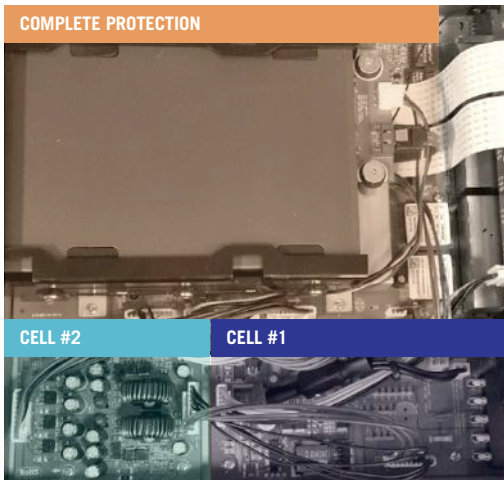

In addition, the isolated power block design protects the main hard drive from vehicle power supply issues, such as an overvoltage event or loss of power. If external power is lost, the internal power supply will ensure all data is written to the disk before shutting down, minimising lost video footage.

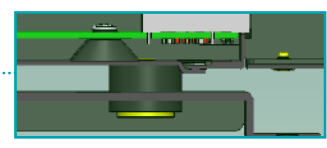
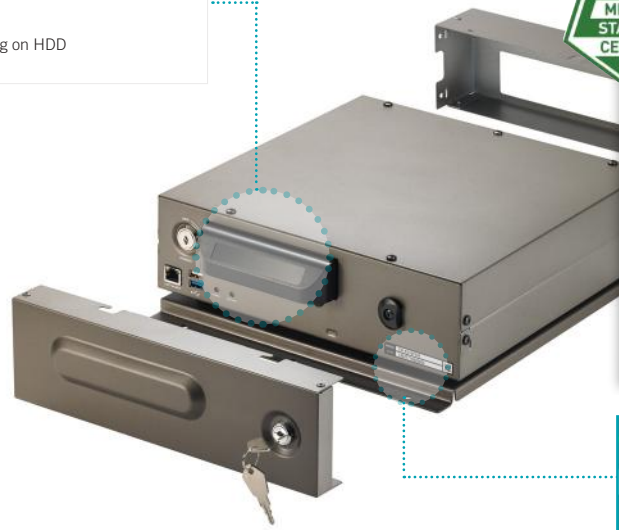
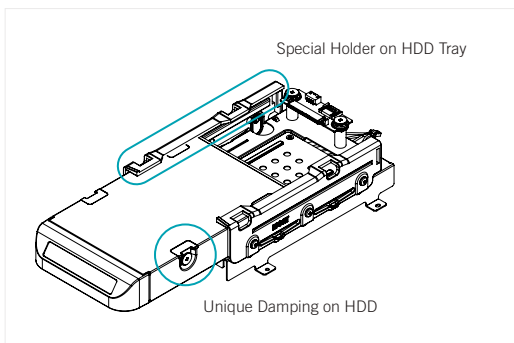
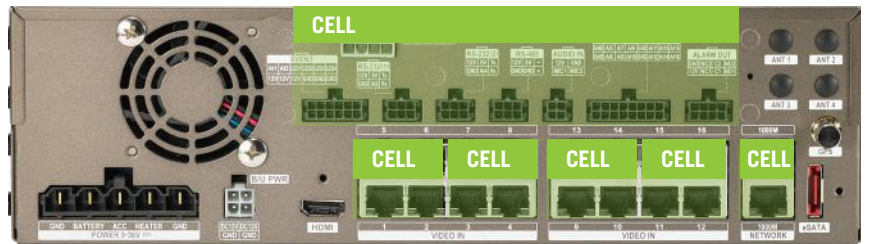

- A specially designed HDD tray dampens vehicle vibrations.
- The NVR case has another layer of protection with a dampened vehicle mount meeting MIL-STD-810.

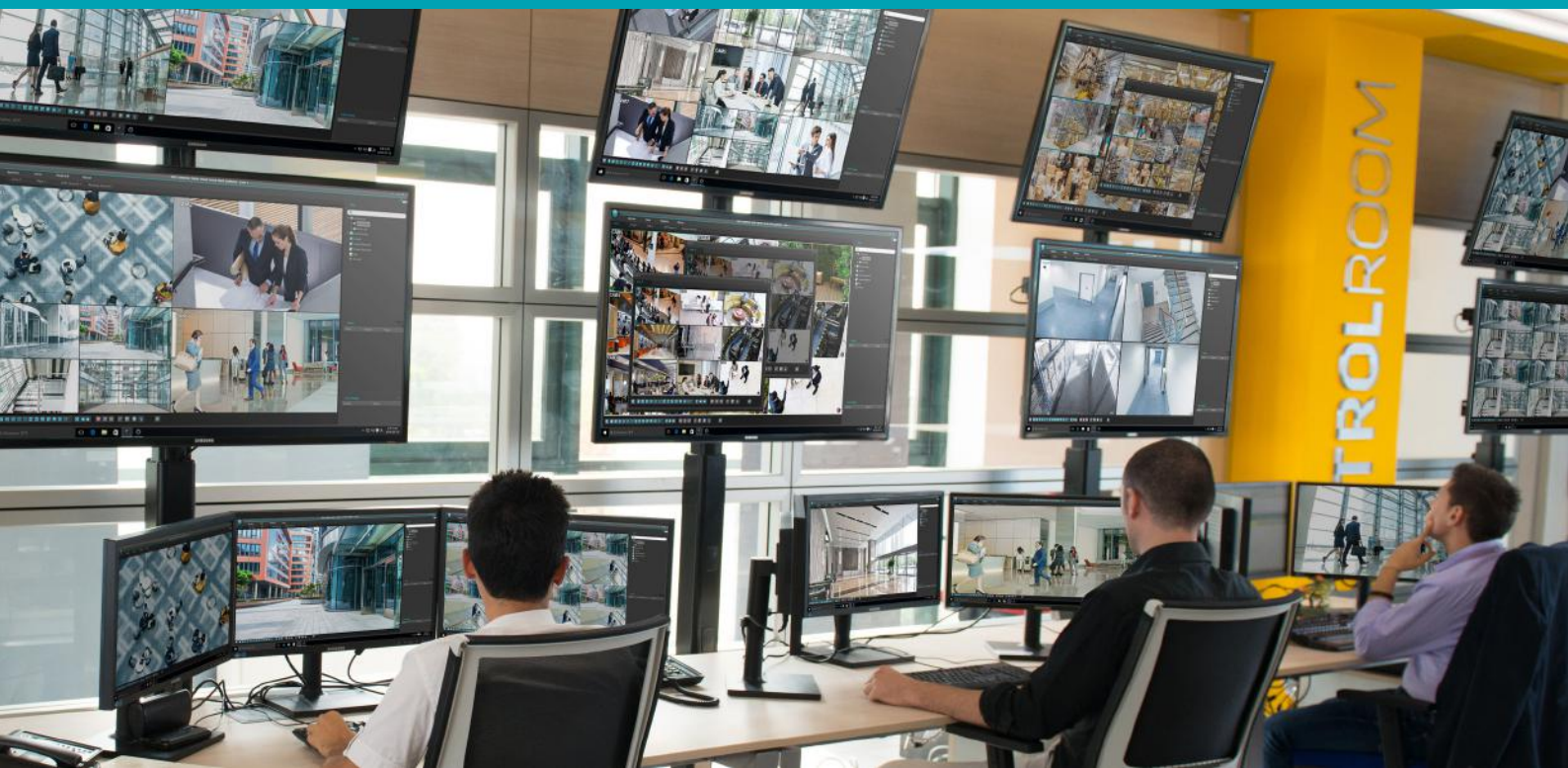

IDIS CENTER

IDIS Center Features & Customisation

IDIS Center is a powerful and customisable VMS that is included for free and supports up to 1024 devices (including mobile NVRs/DVRs).



Power management

Boot up and shutdown power options automatically secure devices during abnormal power and temperature conditions.



Dual stream recording

Dual stream recording separates long term data (low resolution) from short term (high resolution).



Accelerated Configuration

Accelerated configuration based on installation locations. One point of management for all connected devices, effectively managing your entire mobile video recording system as if it were a single device.

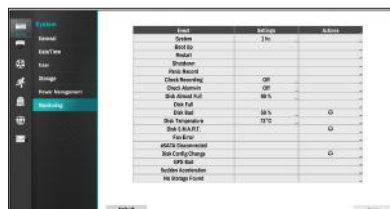

System Monitoring

Comprehensive system health monitoring of all devices and connections.



Map Monitoring

Displays vehicle path, current position, speed and status information in an easy-to-understand map/graph. A simple click on the vehicle icon enables viewing of recorded video.

Central Monitoring and Backup Using ISS

IDIS Solution Suite (ISS) is a full-featured VMS with a modular design, simple and cost-effective license structure and zero software maintenance agreements.

ISS Expert and ISS Backup service modules provide continuous back up of event triggered videos for up to 1024 mobile recorders (MNVRs)

- Full-featured VMS with a modular design
- Simple and cost-effective licensing structures
- Zero software maintenance agreements (SMA)

NETWORK CONFIGURATION OF IDIS SOLUTION SUITE EXPERT

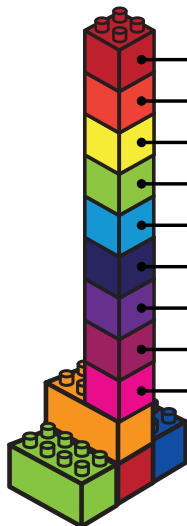
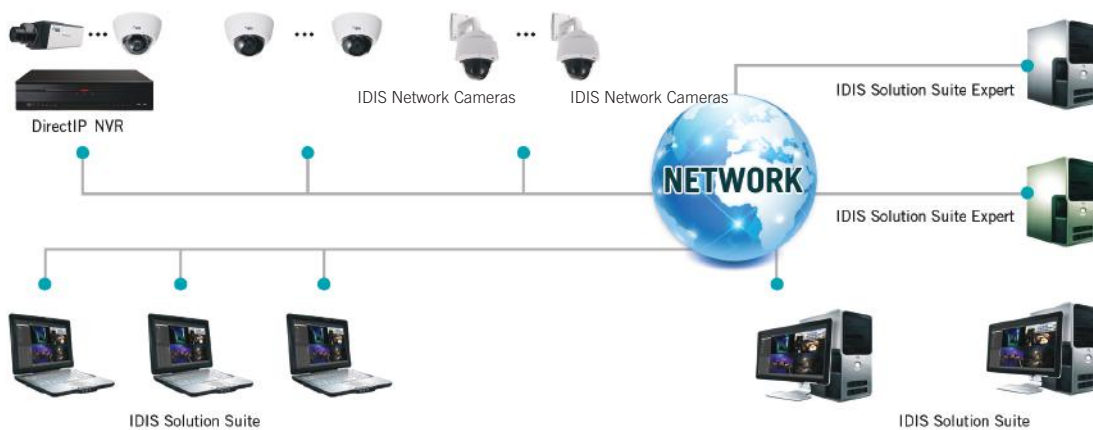

- **Administration** – Central management of devices, services, users and licenses
- **Monitoring** – Central event management and routing
- **Streaming** – Relay and multiply video streams for multiple remote clients
- **Recording** – Recorded video, audio and metadata
- **Redundant** – Tandem recording to a physically separate PC server
- **Backup** – Archived data from recording service and devices
- **Video Wall** – Video wall control and management
- **Federation** – Support for large projects with practically unlimited devices
- **Failover** – Service level redundancy for mission critical applications

DR-6308PM / DR-6316PSM

- Record up to 8/16 high definition cameras
- Durable anti-shock and anti-vibration design
- High recording bandwidth of 210Mbps
- Built-in acceleration sensor



SPECIFICATIONS

Model Name	DR-6316PSM	DR-6308PM
VIDEO		
Video Inputs	16ch x RJ45	8ch x RJ45
Video Outputs	1 HDMI	
Display Resolution	3840 x 2160, 1920 x 1200, 1920 x 1080, 1680 x 1050, 1600 x 1200	
RECORDING		
Compression	H.265, H.264	
Recording Rate	210Mbps, 480ips @ FHD(HQ) + 480ips @ nHD(LT) 210Mbps, 480ips @ 4K(HQ) + 480ips @ nHD(LT)	105Mbps, 240ips @ FHD(HQ) + 240ips @ nHD(LT) 105Mbps, 240ips @ 4K(HQ) + 240ips @ nHD(LT)
STORAGE		
HDD	1 Removable SATA, 1 eSATA	
NETWORK		
Video IN	16 x RJ45(1Gbps)	8 x RJ45(1Gbps)
WAN	1 x RJ45 (1Gbps)	
LAN, Video EXT	2 x RJ45 (1Gbps)	
Wireless	Wi-Fi (Optional)	
INTERFACE		
Audio In / Out	2 / 0	
Alarm In / Out	16 / 2	
Serial Interface	2 x RS232, 1 x RS485	
External Interface	1 x USB 3.0, 1 x USB 2.0	
SENSOR		
GNSS	GPS, Glonass	
3-axis	0	
Temperature	0	
Battery Voltage	0	
ETC		
Dimensions (W x H x D)	285mm x 100.37mm x 320.2mm (11.22" x 3.95" x 12.6")	
Unit Weight	5.08 kg (11.20Lbs) - without HDD	4.98 kg (10.98Lbs) - without HDD
Operating Temperature	0 ~ 50°C (-30 ~ 50°C with heater)	
Operating Humidity	0% ~ 90%	
Power	9~36 VDC	
Approvals	CE, FCC(Class A), E-mark, MIL-STD-810G (Shock & Vibration only)	

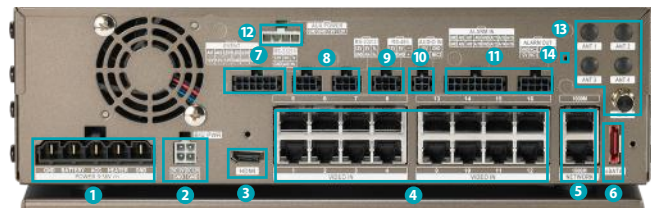

* Storage varies by region.



- | | | |
|------------------|--------------------|-------------------------|
| 1 Power Port | 7 Event Ports | 13 GPS/WiFi Ports |
| 2 USP Port | 8 RS-232 Port | 14 Factory Reset Switch |
| 3 HDMI Ports | 9 RS-485 Port | |
| 4 Video In Ports | 10 Audio Ports | |
| 5 Network Ports | 11 Alarm Ports | |
| 6 eSATA Ports | 12 AUX Power Ports | |

DC-M1212W / DC-M1212R / DC-M1222W (TG)

SPECIFICATIONS

Model Name	DC-M1212W	DC-M1212R	DC-M1222W (TG)*
			
VIDEO			
Image Sensor	1/2.9" CMOS Sensor		1/2.7" CMOS Sensor
Lens	Fixed-focal (2.9mm, 3.3mm, 4.0mm)		Vari-focal (2.8 - 10mm)
Angular Field of View	2.9mm = 115.1(H) x 68.9(V) x 143.7(D) 3.3mm = 101.2(H) X 61.1(V) x 124.4(D) 4.0mm = 81.3(H) x 43.2(V) x 96.6(D)		D = 109.9°(Wide) 40.4°(Tele) H = 94.7°(Wide) 35.3°(Tele) V = 51.4°(Wide) 19.7°(Tele)
Max. Resolution	1920 x 1080		
Scanning Mode	Progressive Scan		
Minimum Illumination	COLOR : 0.07 Lux F2.0		COLOR : 0.1552 Lux F1.2
S/N Ratio	31.2dB		>52dB
Dynamic Range	74.7dB		>70dB
IR Distance	-	10m	-
True Day&Night (IR Filter Changer)	Yes, IR cut Filter with Auto Switch		
NETWORK			
Video Compression	H.264(MP), M-JPEG		
Support Resolution	1920 x1080, 1280 x720, 864 x 480, 640 x 360, 432 x 240		
Video Quality Compensation	Auto Expose, Auto White Balance, Digital Noise Reduction, Black Level Correction		
Ethernet	10/100M		
Event Buffering	Yes (up to 60M)		
ALARM AND EVENT			
Event Trigger	Motion Detection, Tampering, Tripzone	Motion Detection, Tampering, Tripzone, Audio Detection	Motion Detection, Tampering, Tripzone
Alarm	-		
Audio	-	1 (MIC)	-
ENVIRONMENTAL			
Operating Temperature	-10 - 50°C *Starting up at above 0°C (32°F)		
Operating Humidity	0% ~ 90%		
Vandal-proof Casing	IK10		-
Weatherproof	IP66	-	-
ELECTRICAL			
Input Power	48VDC (over Ethernet)		
Power Consumption	4.1W	4.7W	3W
MECHANICAL			
Dimensions (W x D x H) or Ø x H	100mm X 140mm X 65.4mm (3.94"(W) X 5.5"(D) X 2.57"(H))		103.06mm X 172mm X 92.03mm (4.06"(W) x 6.77"(D) x 3.6"(H))
Unit Weight	0.53Kg (1.17lb)		0.71Kg (1.57lb)
APPROVAL			
Electrical	FCC (Class A), CE		
Mechanical	IK10, IP66, MIL-STD-810F	IK10, MIL-STD-810F	MIL-STD-810F

* TG: Optional Tampered Glass

IDIS HQ

IDIS Tower, 344 Pangyo-ro
Bundang-gu, Seongnam-si
Gyeonggi-do, 13493
Republic of Korea

T +82 (0)31 723 5400
F +82 (0)31 723 5100
E sales@idisglobal.com

IDIS Europe

1000 Great West Road
Brentford, Middlesex
TW8 9HH
The United Kingdom

T +44 (0)203 657 5678
F +44 (0)203 697 9360
E uksales@idisglobal.com

IDIS Benelux

De Slof 9
5107 RH
Dongen
The Netherlands

T +31 (0)162 387 247
F +31 (0)162 311 915
E sales@bnl.idisglobal.com

IDIS Middle East

P.O. Box 341037
D-308, DSO HQ Bldg
Dubai Silicon Oasis
Dubai, U.A.E.

T +971 4 501 5434
F +971 4 501 5436
E sales_mena@idisglobal.com



One Solution. One Company.