

# Avax SA 410 Pty LTD

In-Vehicle System (integration & Solutions)



# What makes us Different

## \* Our System Configurator

- 4Ch Recorder DVR – Industrial/Military Grade
- Camera Units – IP66 & Aviation Connections
- Solid State Drive
- No moving Parts
- 12-36Vdc
- Alarm Triggers
- Vandal Proof Casings
- GPS Position / GSM Function / Wi-Fi
- LCD Display for Direct in Cab View
- 2 Year Warranty

## \* Functions & Remote Access

- GPS (Speed and Location) Surface Application
- Remote Access via GSM Module Or Wi-Fi
- DSS – Multiple Devices Monitor and Log Reports
- Event Display & Alert/Alarm Notifications
- Remote Playback
- Access via Remote Server / IOS / Smart Devices
- Live View in Control Rooms
- Live View via Remote DSS Internet Access



# Underground Application

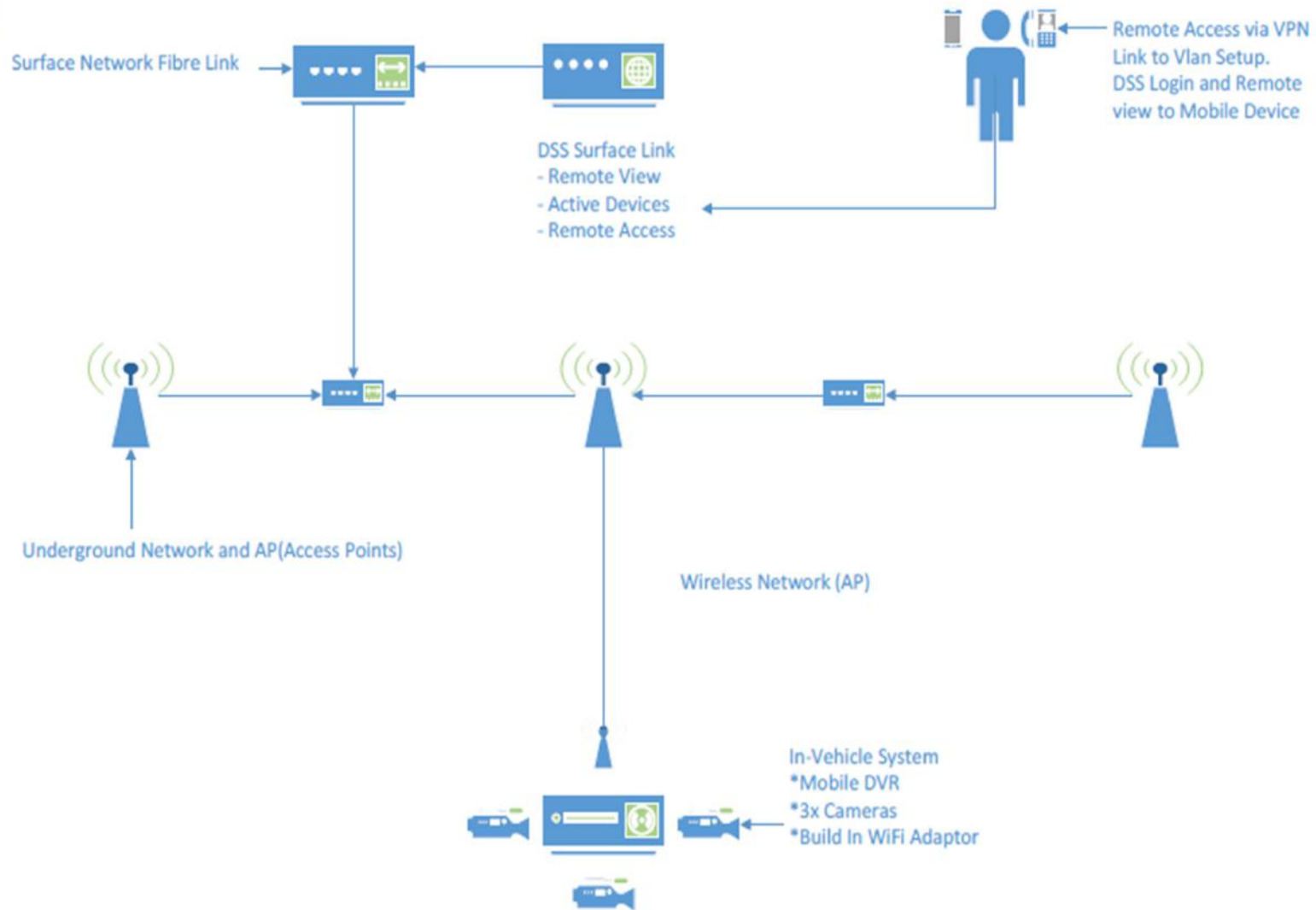

# Surface Application

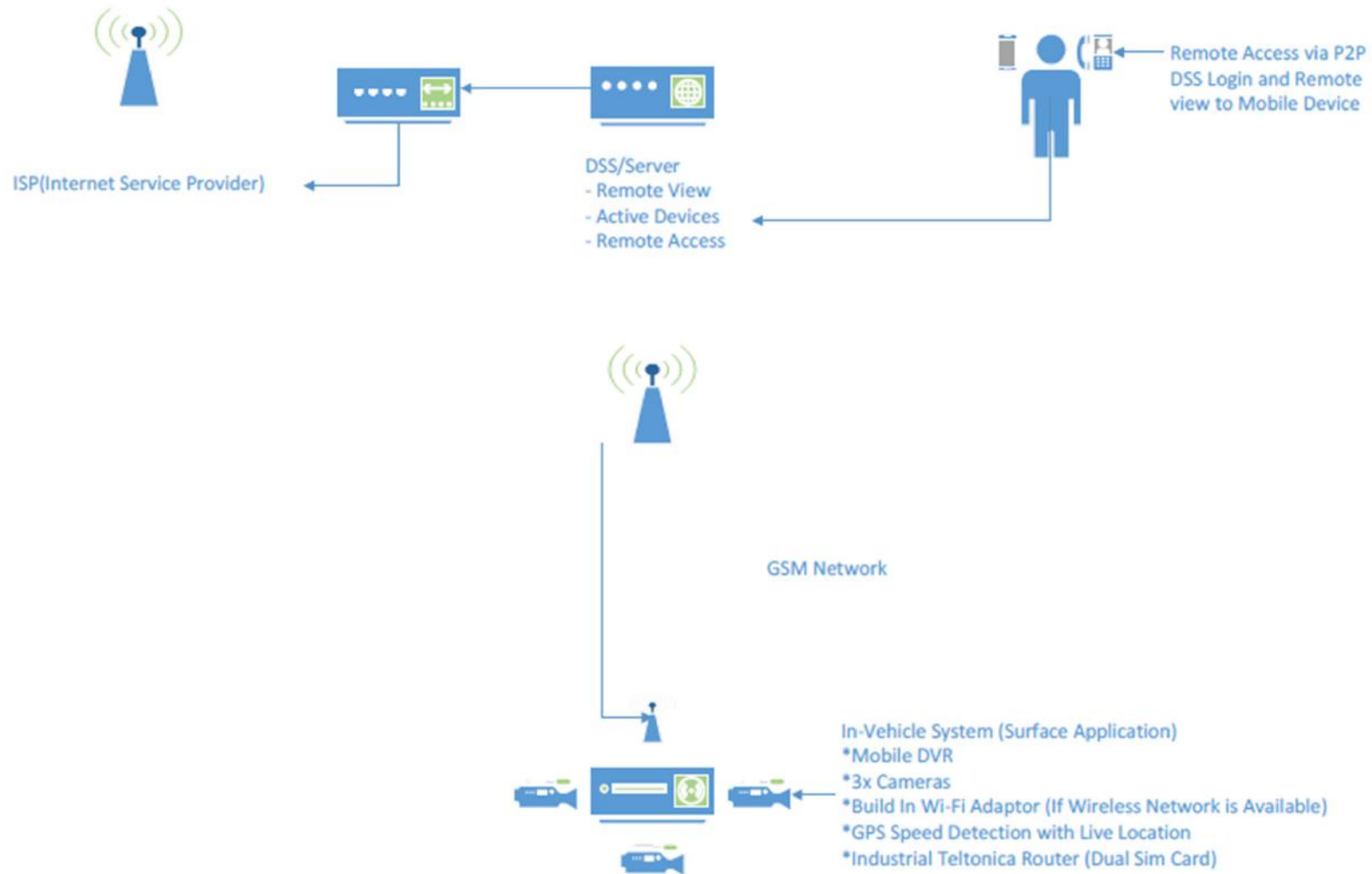

# Open Cast Drilling / In-Vehicle System



# Live View Smart Phone

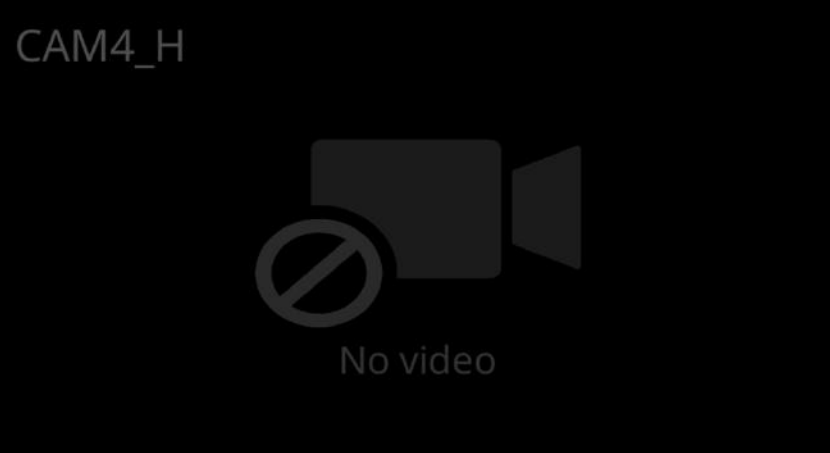

# Live View Drill in Operation

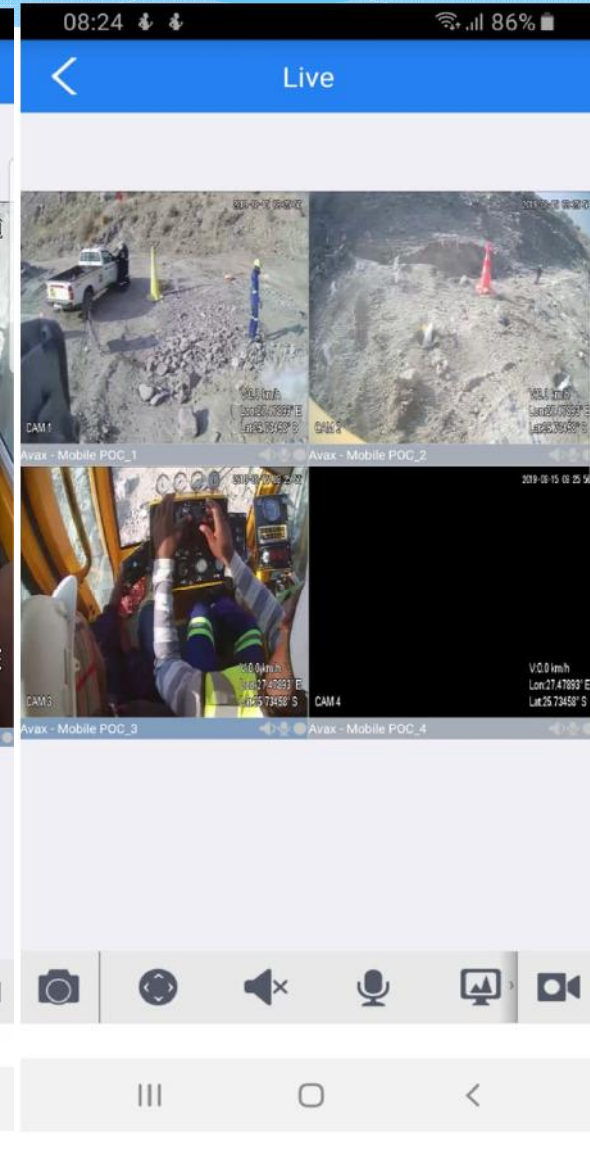
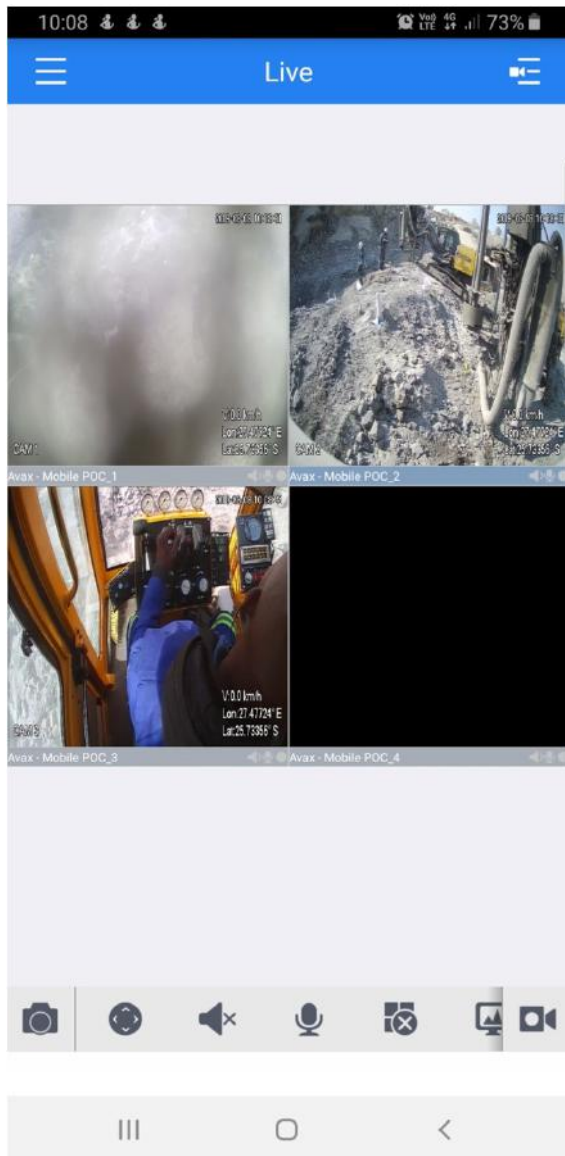

# GPS Position & Tracking

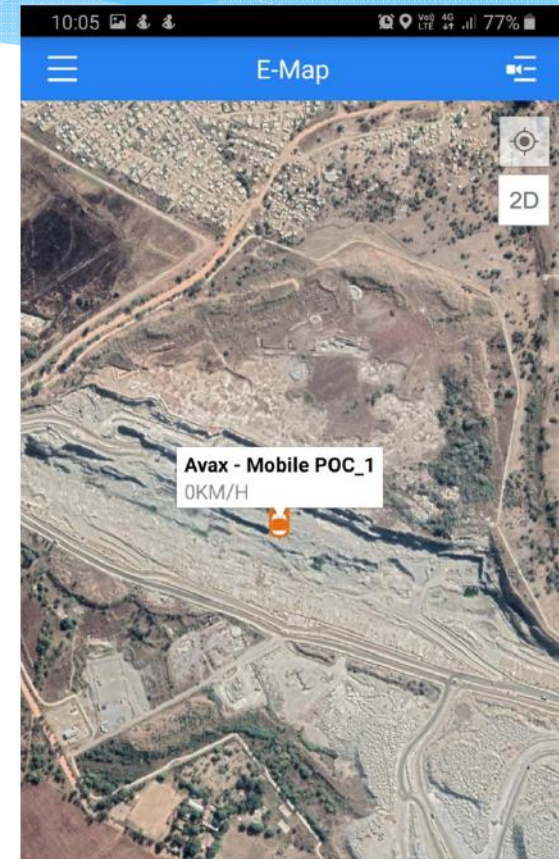
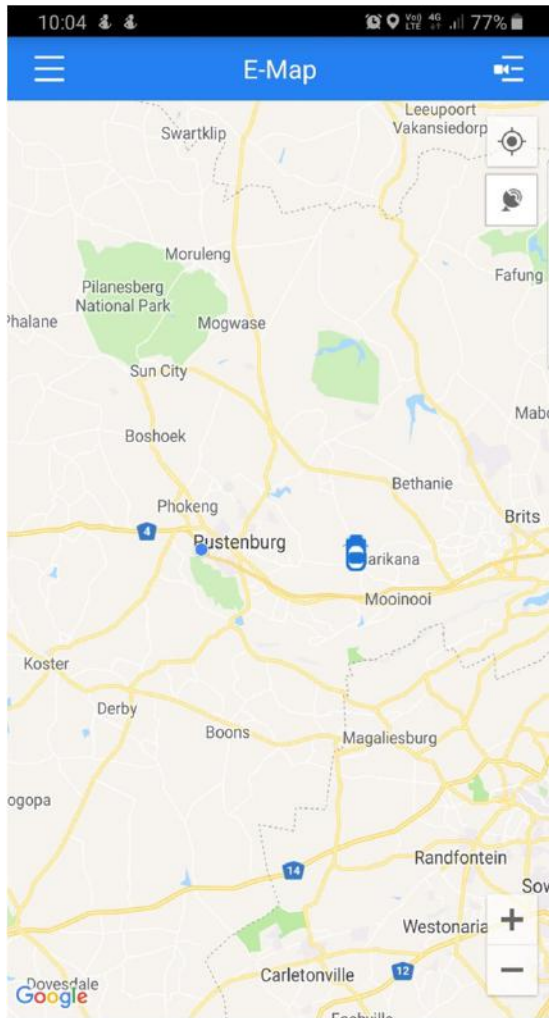

Channel Name : Avax - Mobile POC

[Detail](#)

Asset No. : 1000008

