



Optical Fiber Arc Fusion Splicer

Read this user manual carefully before running KR12A

SWIFT KR12A USER MANUAL

This device complies with Part 15 of the FCC Rules. Operation is subject to the following two conditions: (1) This device may not cause harmful interference, and (2) this device must accept any interference received, including interference that may cause undesired operation.

Device Type	Notification
A Class Device (Broadcasting and communication device, commercial use)	Users need to understand that this device(A Class) has obtained EMI(Electromagnetic compatibility) and been designed to be used in places other than home.

Telephone 042 671 5607~8

Homepage www.uclswift.com

E-mail saleskorea@uclswift.com

TABLE OF CONTENTS

I. FOR YOUR SAFETY	5
II. SPECIFICATIONS	10
2.1 General specifications	10
2.2 Components	11
III. PRODUCT DESCRIPTION	13
3.1 Function Buttons	13
3.2 Part name of Swift KR12A	14
IV. OPERATION	28
4.1 Supplying power to the Swift KR12A	28
4.2 Turn on the Swift KR12A	32
4.3 Installing the sleeve loader / cooling tray	32
4.4 Cleaning the fiber	34
4.5 Inserting the fiber into the sleeve	34
4.6 Placing the fiber into the holder and stripping	35
4.7 Cleaving the fiber	36
4.8 Load the fiber to the Swift KR12A	37
4.9 Splice	38



4.10	Removing the spliced fiber	40
4.11	Heating the sleeve	40
V.	MAINTENANCE	41
5.1	Cleaning and examination prior to splicing	41
5.2	Regular maintenance and cleaning	43
VI.	MENU	48
6.1	Splice	56
6.2	Heat	64
6.3	Auto Stripper menu	68
6.4	Histor	71
6.5	Option	72
6.6	Calibration	76
6.7	Electrode	79
6.8	Setting	82
6.9	Information	85
VII.	ERROR MESSAGE	88
7.1	Too Dirty Fiber	88
7.2	Replace The Fiber In The Correct Position	88
7.3	Too Long Fiber	89
7.4	Fiber Over Angle	89
7.5	Fiber Is Not Placed In V-Groove.	90



7.6 The Variation Of The Optical Fiber Core.	90
7.7 Mismatch Fiber Number	91
7.8 Core Bubble Error	91
7.9 Gap Limit Over	92
VIII.HOW TO DEAL WITH SPLICING PROBLEMS	93
8.1 When the splice loss is too high	93
8.2 Abnormal operation of arc fusion splicer	94
IX. Q & A	95
9.1 Power	95
9.2 Splice	96
9.3 Sleeve heater	97
9.4 The others	98
X. WARRANTY PERIOD AND SERVICE	99
10.1Information required for repair	99
10.2Transport	100
10.3Repair	100



I. For your safety

The Swift KR12A is designed to satisfy the user's convenience for both outdoor and indoor use, allowing the operation easy and simple. Still, we strongly recommend our customers to read this user manual carefully prior to running the Swift KR12A in order to prevent any accident and breakdown because improper handling may cause danger. This user manual provides all the necessary information to ensure splicing safely.

Keep this User manual with the device at all times.

UCLSWIFT Co., Ltd is not liable for any personal injury, any physical loss and damage to device caused by inappropriate use or unauthorized modification of the equipment.

Warnings

Please, turn off the Swift KR12A and disconnect the AC power cord from the AC adapter inlet or the wall socket immediately and contact UCLSWIFT Co., Ltd. If any of following incidents occurs while operating.

- Fumes, odor, noise or overheating.
- Liquid or foreign substances fall into the device.
- The splicer is dropped or damaged.

Use the supplied power cord with the Swift KR12A only. Using an improper AC power cord may cause fire, electric shock or personal injury.

DO NOT touch the electrode when the Swift KR12A is on. The high voltage and temperature generated by electrode may cause electric shock or burn.



Connect the supplied AC power cord to the battery. Check to ensure no dust or foreign substance on the AC plugs before connecting it. Unsafe connection may cause the fumes, fire or damage to the Swift KR12A and result in serious personal injury or death.

Warnings

Apply correct voltage. The correct input AC power to the adapter is AC 100-240V and 50-60Hz. Abnormally high AC output voltage or irregular frequencies are often generated by AC generator. Please measure the AC output voltage with a circuit tester. Since abnormal high voltage and frequencies may result in serious electric shock, injury, death or damage to the equipment, it is important that regularly check the generator before use. DO NOT excessively pull, amend, misuse or apply heat to the AC power cable. Using a damaged power cable may result in fire or personal injury. Connect 3-core AC power cord. DO NOT use 2-core, cable and plug.

DO NOT touch the AC plugs, AC power cable or the Swift KR12A with wet hands. It may cause an electric shock.

DO NOT disassemble the AC adapter, battery or the Swift KR12A. Any modification may cause fire, electric shock or personal injury.

When using the battery, follow instructions below.

- Using battery other than in the package or provided by UCLSWIFT Co., Ltd may cause fumes, damage to the device, burn, serious injury or even death.
- DO NOT throw the battery into fire or an incinerator.
- DO NOT charge the battery near a flame.
- DO NOT apply excessive shock to the battery.
- If the battery is not fully charged or the green LED is not turned on in about two hours, stop charging immediately and contact UCLSWIFT Co., Ltd. DO NOT put anything on the AC adapter while charging.

Use the supplied AC adapter (F1-1) at all times. DO NOT use other type of AC power cord and the battery. Excessive electric current may cause damage to the machine and personal injury.

DO NOT run the Swift KR12A near flammable liquid or explosive gas storage. The electric arc of the Swift KR12A may cause fire or explosion.

Warnings

DO NOT clean the Swift KR12A using compressed air or gas.

Please check the shoulder belt before transporting. Transporting the case with a damaged shoulder belt, it may cause the damage of the Swift KR12A and the personal injury.

Make sure to wear protective glasses while performing splicing works. If the fiber fragments come into contact with the eye or skin, it can be extremely dangerous.

DO NOT operate the Swift KR12A at a high temperature or near heat, otherwise personal injury or damage to the device may occur.



: EXTREMELY HOT



: DO NOT SPRAY FREON GAS



: CAUTION HIGH VOLTAGE

Cautions

DO NOT touch the sleeve heater or the sleeve during or immediately after heating them. The hot surface may cause skin burn.

DO NOT place the Swift KR12A in an unstable or unbalanced position. The machine may fall, causing injury or damage to the Swift KR12A.

The Swift KR12A is precisely adjusted and aligned. DO NOT allow the unit to receive a strong impact. Use supplied carrying case for its transportation and storage. The carrying case protects the Swift KR12A from damage, moisture, shake and shock during storage and transportation.

Replace the electrodes in a timely manner and maintain them as instructed below ;

- Use only a specified electrode.
- Place a new electrode in the correct.
- Replace the electrodes as a pair.

Incompliance with above instructions may cause abnormal arc discharge, resulting in damage to the machine or degradation in splicing performance.

Use no chemicals other than ethyl-alcohol (96% or greater) to clean the objective lenses, V-groove, V-block, LCD monitor and body of the Swift KR12A. Otherwise, blurring, discoloration, damage or performance deterioration may occur. The Swift KR12A requires no lubrication. Oil or grease may degrade its performance and damage the equipment.

DO NOT store the Swift KR12A in a place where temperature or humidity is high. Damage to the machine may occur.

II. Specifications

2.1 General specifications

Subject	Description
Fiber alignment	Ribbon
Applicable fibers	SM(G.652), MM(G.651), DS(G.653), NZDS(G.655), SM(G.657)
Fiber count	Single fiber, 2~12 Ribbon fiber
Applicable fiber dimensions	Single: Cladding diameter 125 μ m, Coating diameter 250 μ m, 900 μ m Ribbon: Cladding diameter 125 μ m, Ribbon fiber thickness 0.25 to 0.40mm
Fiber cleave length	10mm
Splicing modes	Splicing: 300, Heat: 100, Strip: 50
Average splice Loss	SM: 0.05dB, MM: 0.02dB, DS: 0.08dB, NZDS: 0.08dB
Return loss	> 60dB
Splicing time	Typical 20 sec with standard SM (ITU-T G.652)
Splice loss estimate	Available
Sleeve heating time	1~2 core 20 sec 4~12 core 50 sec
Applicable protection sleeve	40mm, 60mm (Fiber)
Storage of splice result	The last 10,000 results to be stored in the internal memory. (Image 10,000 results)
Tension test	2N / 4.4N (Option)

Operating conditions	Altitude: 0~3,660m above sea level, Temperature: -10°C~50°C, Humidity: 0~95%, Wind: 15m/s, Non-condensing, Dust proof, Water proof, Shock proof
Storage conditions	Temperature: -40°C~80°C, Humidity: 0~95%
Dimensions	136(W) x 215(L) x 132(H)mm (Excluding bumper)
Weight	2.3kg (Including battery)
Viewing method and display	Two CMOS cameras and 5.0-inch color LCD monitor with Electrostatic touch screen
Fiber view and magnification	20X, Max 60X
Power supply	100~240V AC
Battery life with heat-shrink	Typical 170 cycles (6000mAh)
Electrode life	Up to 3,000 splices
Terminals	USB, External power(DC 12V available for car cigar jack)
Cleaver	CM-03RT
Cleaver blade life	Up to 2,000 times for 12 fibers

2.2 Components

2.2.1 Standard items

No	Description	Model No.	Quantity
1	Arc Fusion Splicer	SWIFT KR12A	1







2	User guide	Download from UCL Swift website	
3	Spare electrode	EI-28	1 pair
4	Cooling Tray	-	1
5	Transporting Case	Hard Case	1
6	Battery	K3360(6000mAh)	1
7	AC Adapter	100-240V	1
8	Fiber Holder	H7-Series	1 pair
9	Tool box	-	1
10	USB Cable	-	1
11	Upgrade Cable	-	1

2.2.2 Optional items

No	Description	Model No.
1	Battery	K3360(6000mAh)
2	Cleaver Blade	BI-07
3	Electrode	EI-28
4	External Power	DC 12V available for car cigar jack
5	Sleeve	R-F40 (40mm)
6	Sleeve Clamp	-
7	Sleeve Loader (2ea)	-
8	Optical Fiber Holder	H7-4-10, H7-8-10, H7-12-10, H7-250-10, H7-900-10, H7-2.5-10, H7-IN-10, H7-2-10, H7-6-10, H7-10-10, MPO-10, KR7-12
9	Wifi Card	-
10	Ribbonizing Holder Kit	-
11	Ribbon Separator	IRS-01
12	WiFi Card	WBM-01

III. Product Description

3.1 Function Buttons

Button	Description
	<p>To turn the power on/off-press button for about 1.0 second. Press for about 1 second in POWER ON status, the LCD monitor turns off. Turn off the power after 2~3 seconds.</p>
	<p>To call the main menu screen.</p>
	<p>To execute splicing command.</p>
	<p>To return to the initial screen. To initialize the splicing function.</p>
	<p>To activate the sleeve heater.</p>
	<p>To supply power to the Automatic Fiber Stripper heater.</p>

3.2 Part name of Swift KR12A

3.2.1 Components



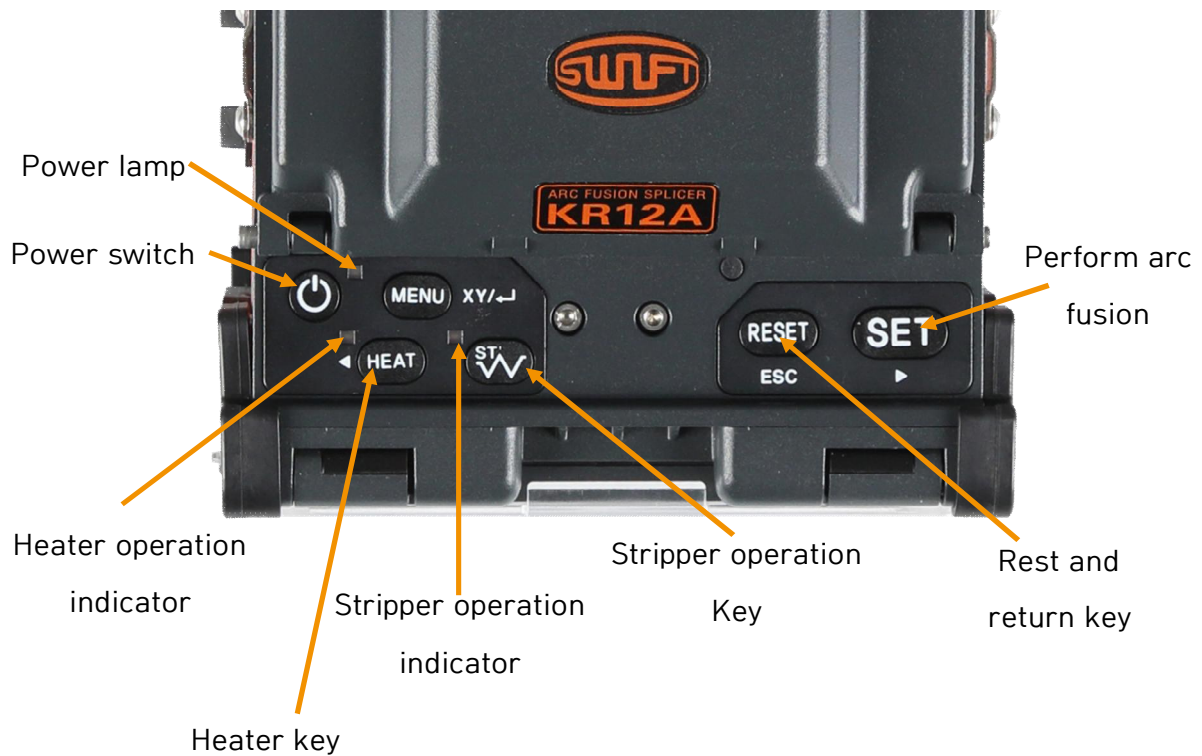
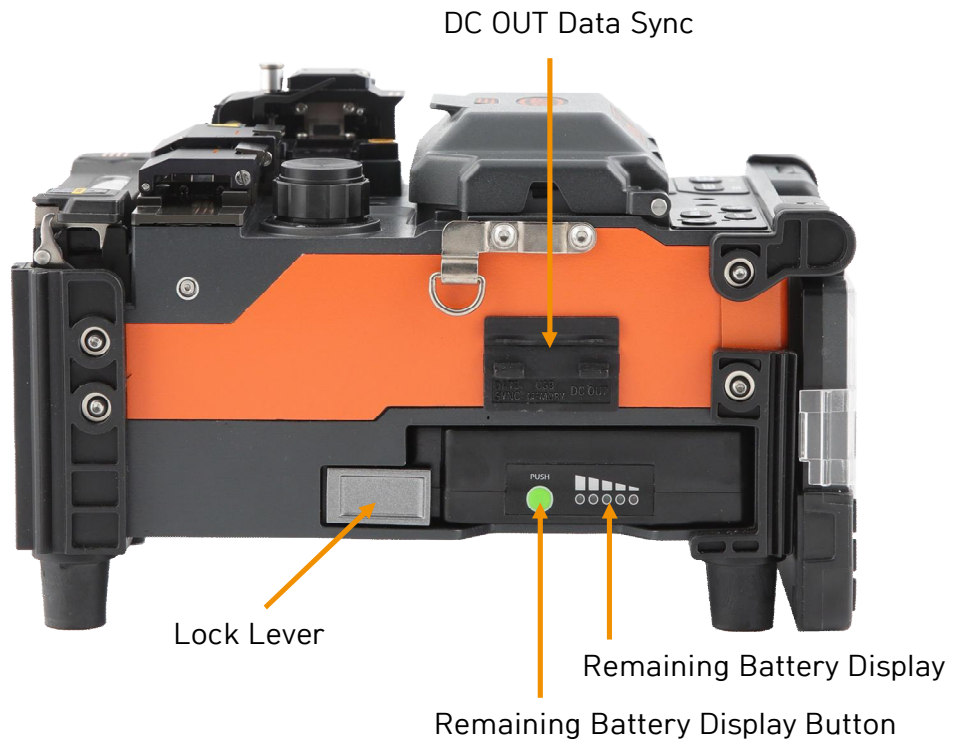

3.2.2 Arc fusion splicing assembly

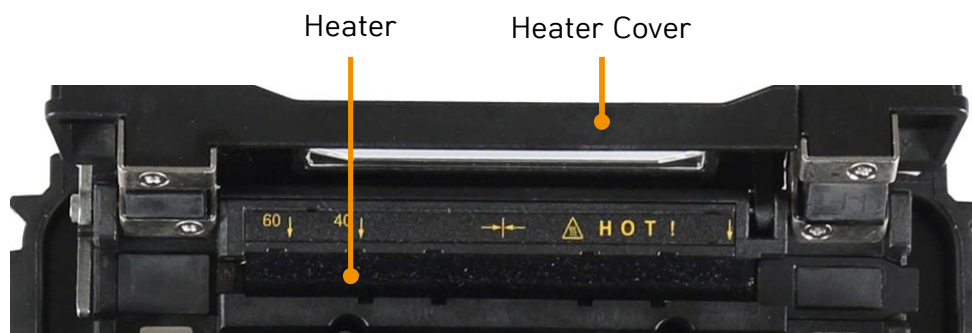
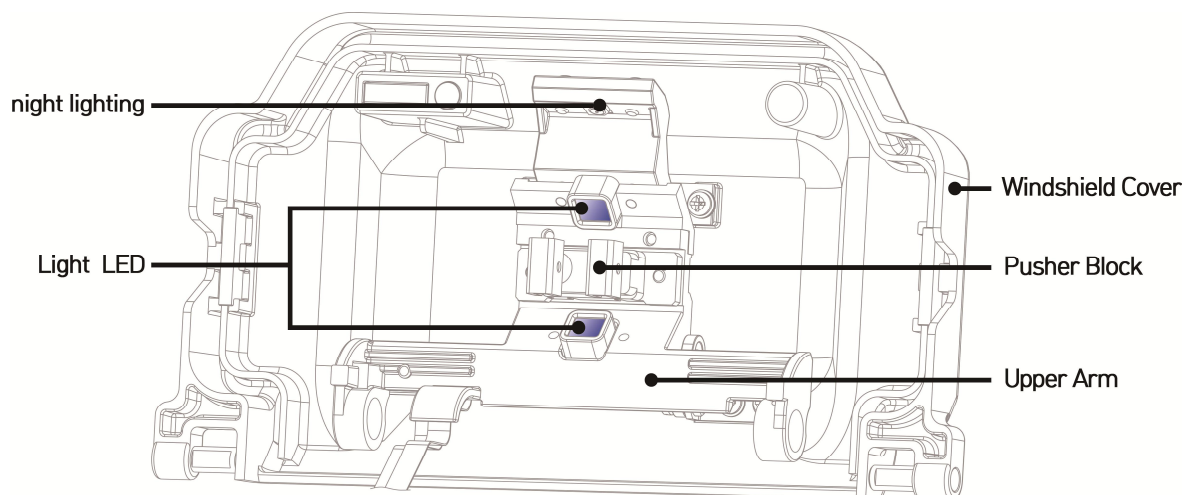
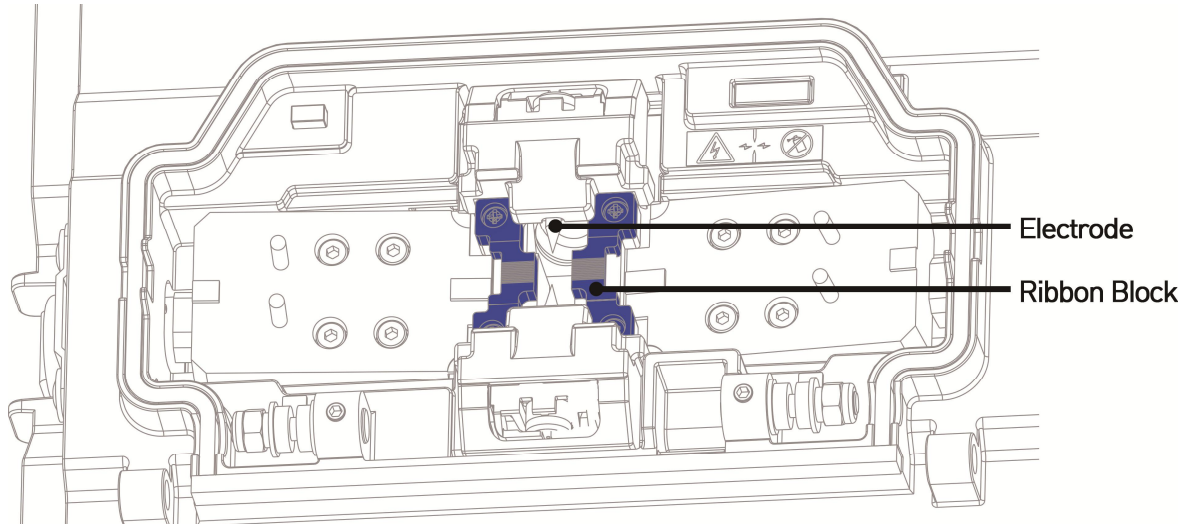

3.2.3 Swift KR12A Auto Stripper

Swift KR12A automatic fiber stripper automatically carries out an accurate stripping of the coating of single- and multi-mode fibers. Featuring excellent tensile force of fiber, the automatic stripper strips up to 28.0mm in length without damaging the surface of fiber. Read the user manual sufficiently to maintain the best performance of the unit.

 Be careful not to wet the equipment.

Maintain the unit in a clean condition at all times because many of splicing problems are caused by dust or moisture.

Keep and use the unit at room temperature as it could be deformed by heat.

Keep the equipment from being shaken or physically impacted as it could be broken.

Never use organic solvents such as acetone except alcohol to clean rubber part of the equipment.

3.2.3.1 Specifications

No	Subject	Description
1	Applicable Fiber Diameter	125 μ m
2	Applicable Cable Diameter	250 μ m, 900 μ m
3	Strip Length	Max 28.0 mm
4	Heating Time	0 ~ 15 sec
5	Heat Temp. Range (HEATING TYPE)	60 °C ~ 150 °C
6	Tensile Force after Stripping	4kgf

3.2.3.2 Configuration and name of each part

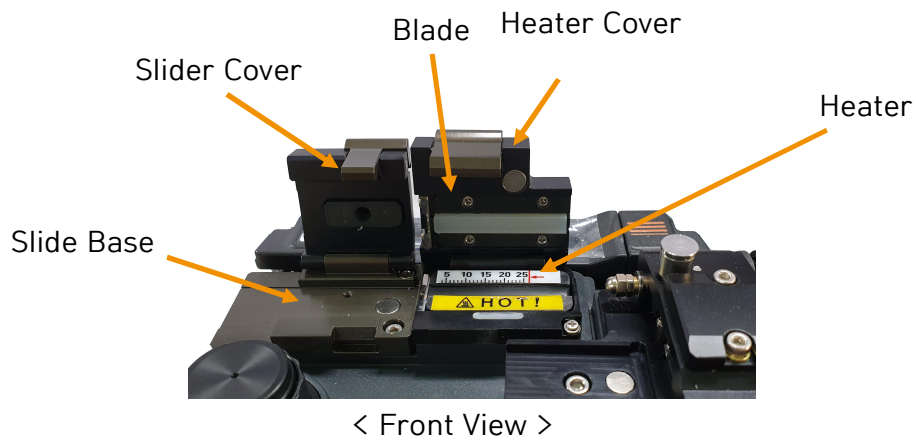

<Monitor>



< Control Panel >

3.2.3.3 Operation Procedure (Fiber stripper)

- i. Warm up the thermal stripper after applying power to the control area.
Open thermal stripper cover and slide cover for preparation.



< Monitor >



< Control Panel >

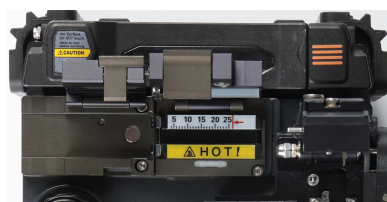

<Front View>

- ii. Place fiber into the holder as shown below pictures. The minimum stripping length should be longer than 18mm.

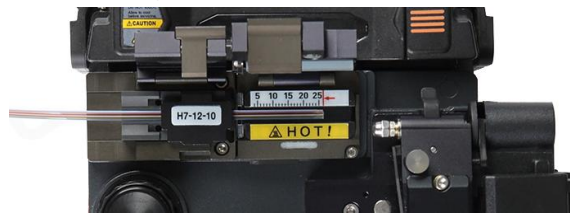

<12 type>

- iii. Mount the holder containing the fiber onto the slider and close slide cover.



<12 type>

- iv. Once the thermal stripper cover is closed, the fiber is heated up for a pre-defined time and the coating is stripped by moving the slider.



<12 type>

- v. When stripping is completed, open the slide cover and detach the holder containing the stripped fiber. The slider part moves to the initial position as thermal stripper cover is opened.
- vi. Remove any remaining coating residue from thermal stripper and blade areas using a soft brush for next operation.
Be careful in handling blade part which is very sensitive.



3.2.3.4 maintenance

[Replacement & Adjustment of Blade]

- i. Remove worn out blade by unscrewing fixing bolts as shown below picture. At this time, move the slide part to the left hand side.

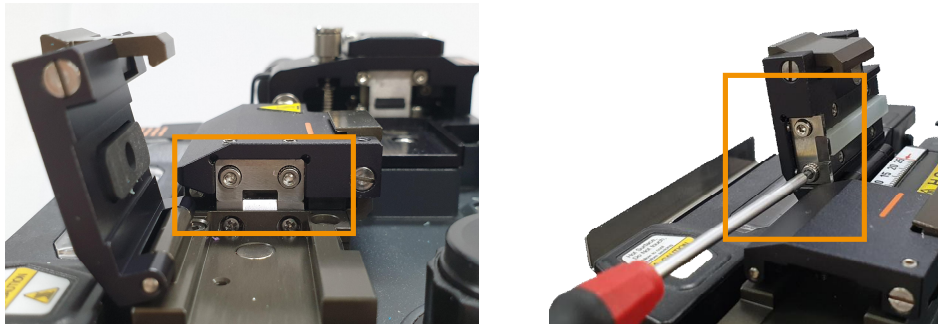

- ii. Place new blades in the reverse manner of removing.
(Two blades as a pair at top and bottom)
Make sure that both blades fit tightly in place in order to achieve a good strip result.

[Handling and storage]

- Be careful of using, handling or storing principal parts including blades, heater, etc as they are closely related to the equipment's operation life.
- Do not apply unnecessarily weight or physical impact in handling the equipment.
- Keep the principal parts of the equipment in a clean condition always.
- Keep it clean and in a case when not using, which will increase the life of the equipment.

3.2.4 Swift KR12A Cleaner

The alcohol dispenser in the Swift KR12A has a limited capacity; the alcohol pump can be removed and refilled with cleaning fluid.



<Assembled>

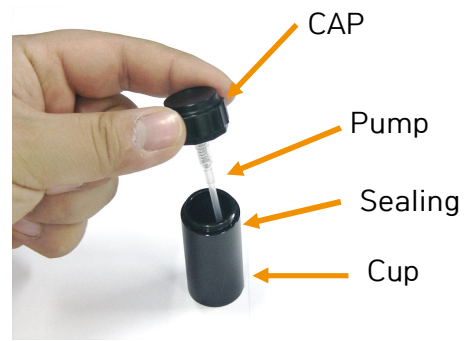

< Disassembled >



Be careful not to wet the equipment.

Maintain the unit in a clean condition at all times because many of splicing problems are caused by dust or moisture.

Keep and use the unit at room temperature as it could be deformed by heat.

Keep the equipment from being shaken or physically impacted as it could be broken.

Never use organic solvents such as acetone except alcohol to clean rubber part of the equipment.

i. When cleaning, press down on the alcohol dispenser 2 or 3 times, using cleaning cotton (wipe) as shown in the picture below.

At this time, to avoid splashing the alcohol please cover the top part of dispenser with cleaning cotton and push it.



ii. If no alcohol is discharged, open cap and refill the dispenser.

Add alcohol after completely removing it from the Swift KR12A body by pulling upward. It is connected to the body by magnet.



iii. The recommended cleaning fluid is MCC-POC03M.

3.2.5 Swift KR12A Cleaver

The cleaver is designed to cleave the fiber at a 90 degree angle.
For the best result, following requirements should be met.

- i. The coating of fiber shall be cleanly stripped.
- ii. The fiber shall be properly placed on the holder upon cleaving.
- iii. The physical condition and height of the cleaver blade shall be adequately maintained.

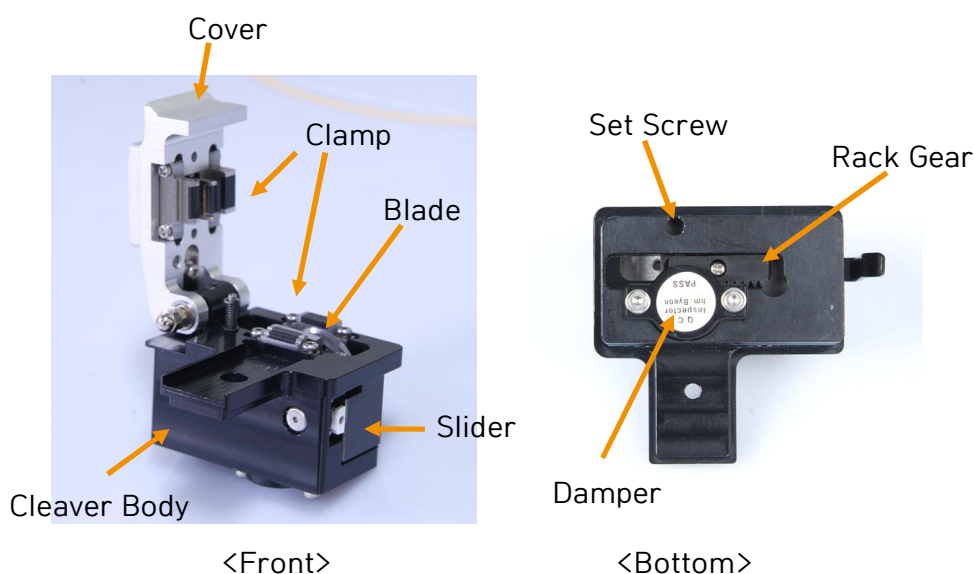
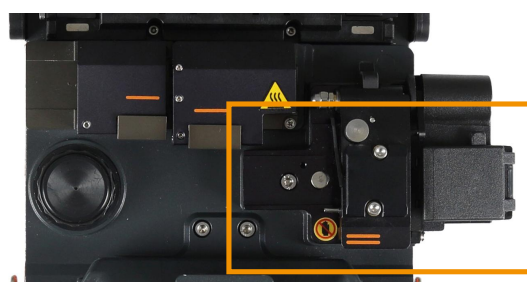

- ⚠ Be careful not to wet the equipment
Maintain the unit in a clean condition at all times because many of splicing problems are caused by dust or moisture.
Keep and use the unit at room temperature as it could be deformed by heat.
Keep the equipment from being shaken or physically impacted as it could be broken.
Never use organic solvents such as acetone except alcohol to clean rubber part of the equipment.

3.2.5.1 Operation Procedure (Fiber Stripper)

- i. Open cover and set the holder containing stripped fiber into the cleaving position. Check whether the fiber is lying in place. Use the chip-box located at the right side of the body.

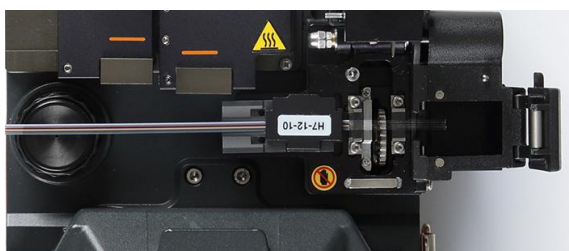

<12 type>

- ii. Press the cover to cleave the fiber.

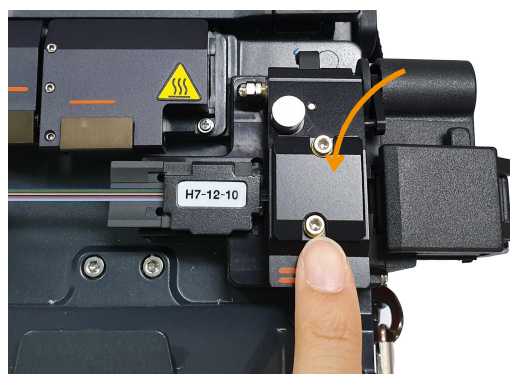

<12 type>

- iii. Open the cover and check the result.

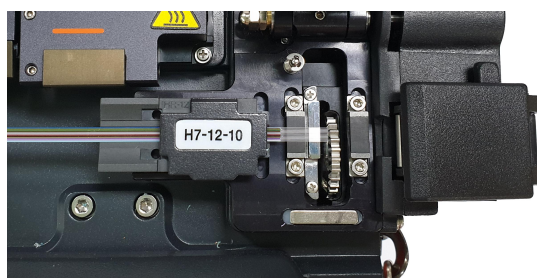

<12 type>

- iv. Take out the cut fiber and holder. Be careful not to contaminate the fiber with dust or foreign substance. The fiber shards are collected in the slide-type chip-box placed at the side of Swift KR12A body.

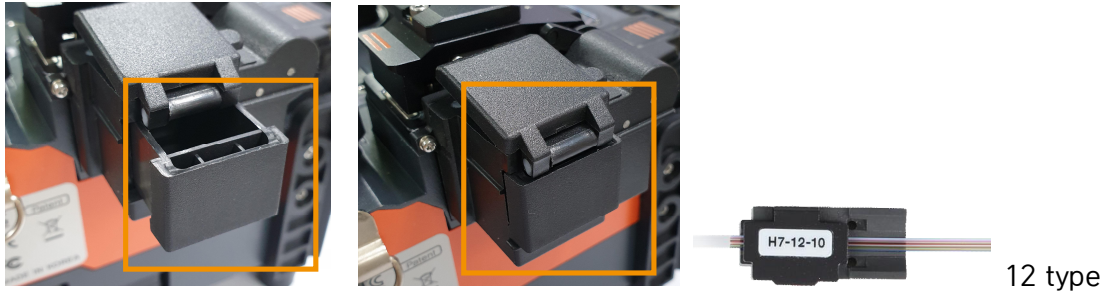

3.2.6 Swift KR12A Sleeve-heater

The sleeve heater is designed to strengthen the fiber splice.

To ensure maximum reinforcement the following conditions must be met.

- i. After splicing the fiber splice must be visually perfect.
- ii. The fiber and sleeve must be placed correctly in the heater, failure to place the sleeve and fiber in the correct position can result in incorrect heating and possible damage to the splice joint.
- iii. When splicing, the heater cover cannot be left open, it must be in the fully closed position.

3.2.6.1 Specifications

No	Subject	Description
1	Applicable Cable Diameter	250μm, 900μm, 2.0 - 3.0mm, 2~12fiber
2	Sleeve Length	32mm(standard)
3	Sleeving Time	20~35 sec
4	Heat Temp. Range	130°C ~ 200 °C



⚠ Be careful not to wet the equipment.

Maintain the unit in a clean condition at all times because many of splicing problems are caused by dust or moisture.

Keep and use the unit at room temperature as it could be deformed by heat.

Keep the equipment from being shaken or physically impacted as it could be broken.

Never use organic solvents such as acetone except alcohol to clean rubber part of the equipment.

3.2.6.2 Operation Procedure (Heating Sleeve)

[Sleeve Procedure]

- i. As shown in the picture below, apply power to the control panel and open the cover of the heater to prepare.



- ii. Set the sleeve tube to the area of arc-fused fiber that needs to be reinforced and place the fiber inside the heater. The connector type should be set to the right-most position so that sleeve tube moves the heater as closely as possible.

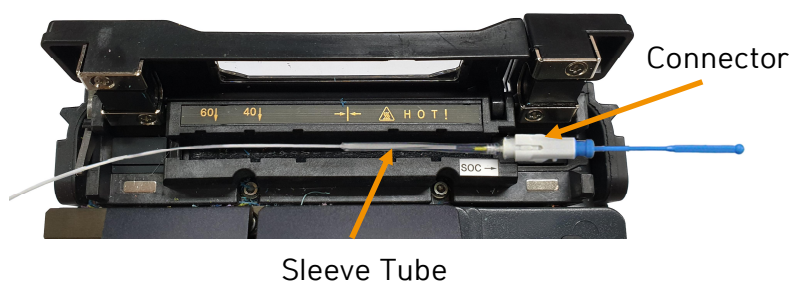

- iii. Activate the heater after placing the fiber. Cooling fan is run to cool the tube 20 seconds after heater activation.



- iv. Open the cover when cooling is completed and take out the reinforced fiber.

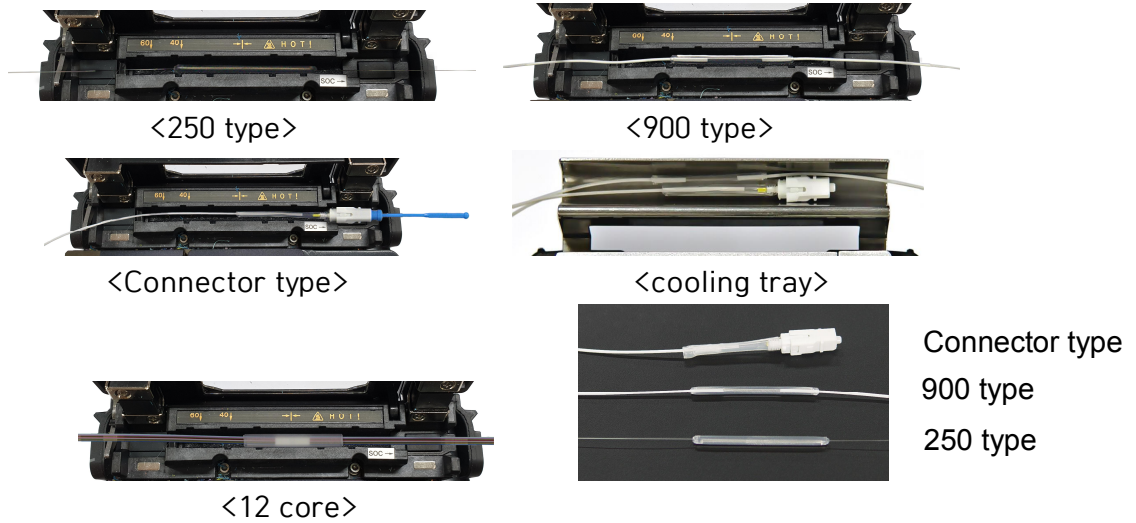

3.2.6.3 Maintenance

[Handling and storage]

- Be careful in using, handling or storing principal parts including blades, heater, etc as they are closely related to the life of the equipment.
- Do not apply unnecessarily weight or physical impact in handling the equipment.
- Keep the principal parts of the equipment in a clean condition always.
- Keep it clean and in a case when not using, which will increase the life of the equipment.

IV. Operation

The initial screen is displayed as below. It is important to choose a right splice mode and heat mode to ensure an accurate splicing result. The basic information of the Swift KR12A is displayed on the initial page. Before splice, make sure the appropriate mode is selected.

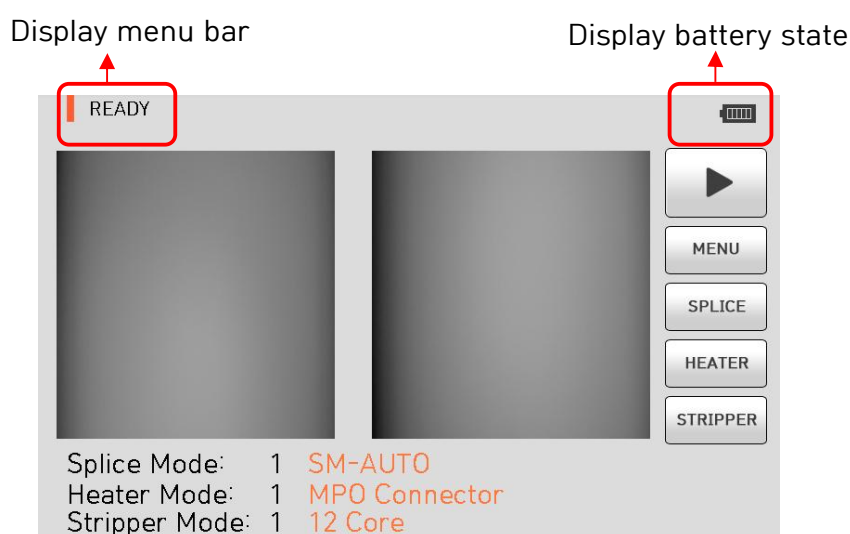

4.1 Supplying power to the Swift KR12A

It is strongly recommended to use the AC adapter (F1-1) and battery (KR12A13) provided with package. Using a battery other than provided may cause fumes, fire, and damage to the device, personal injury and death.

4.1.1 How to insert and detach the battery



Insert the battery into the battery groove until it clicks.

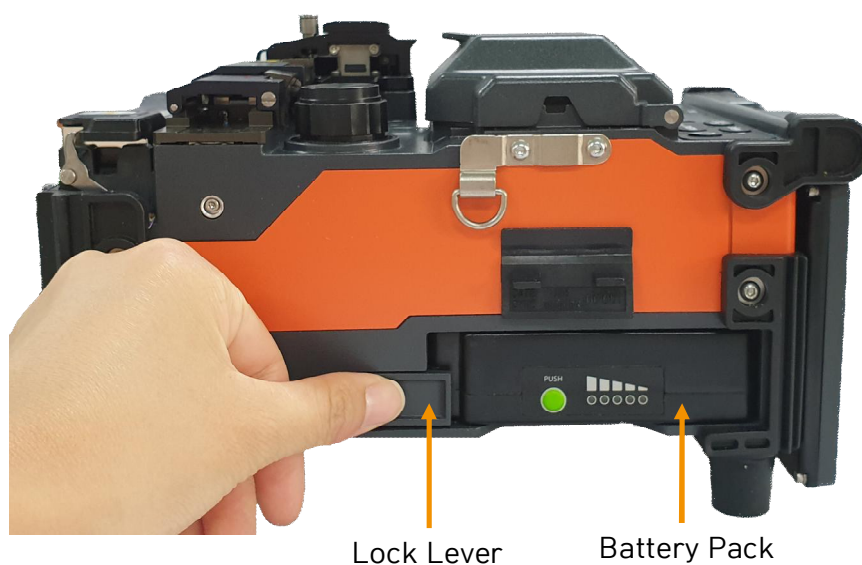

Please make sure the power is off before removing the battery. Remove the battery by releasing lock lever.

4.1.2 How to charge the battery





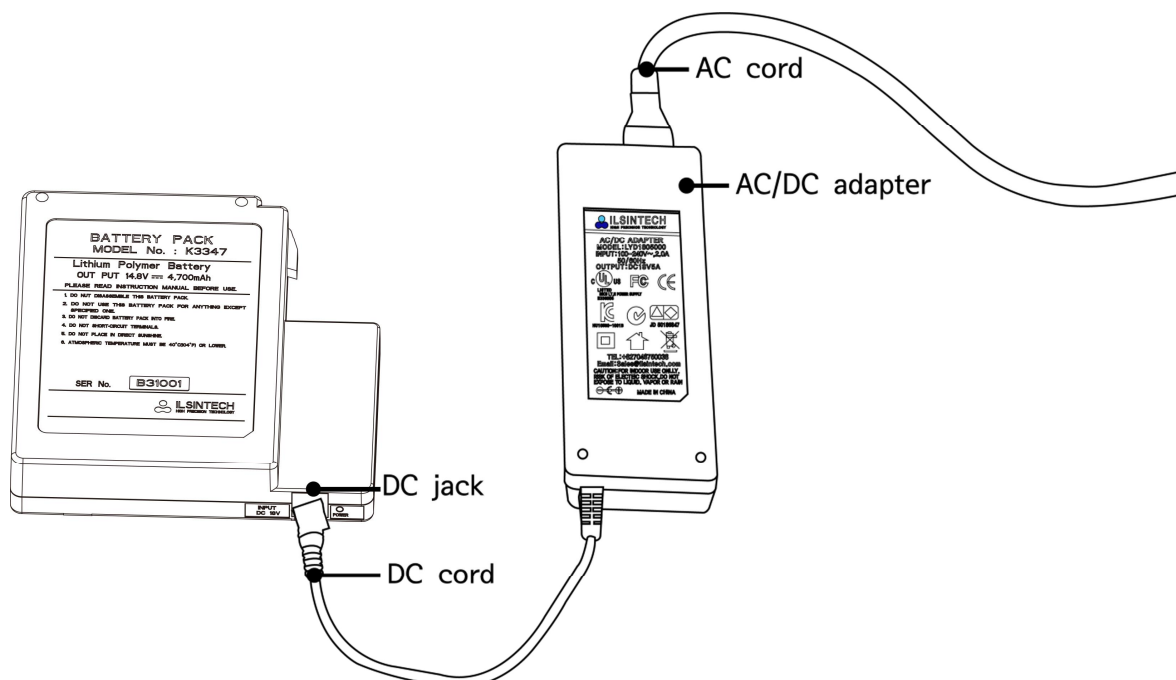





Make sure the voltage and frequency and connect the DC cord of the AC/DC adapter to the DC jack of the battery. The LED turns to green when the charging is completed. The battery includes the protection circuit that prevents full discharge and full charge. The supply of power stops once the protection circuit is activated. In order to deactivate the protection circuit and resume feeding power, wait about 10 seconds and connect again the DC cord to the DC jack.

Swift KR12A can be charged during operation because the floating charging method is applied. The battery can be also charged with 12V Cigar jack charger.

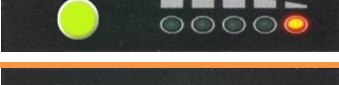

4.1.3 How to check remaining battery capacity

Press  to check the remaining battery capacity.

Remaining battery amount (Monitor)	Remaining battery capacity display (LED)	Percentage remains
 (5 bars)	 5 LED	80 ~ 100%
 (4 bars)	 4 LED	60 ~ 80%
 (3 bars)	 3 LED	40 ~ 60%
 (2 bars)	 2 LED	20 ~ 40%
 (1 bar)	 1 LED	10%
 (No bar)	 0 LED Nothing displayed	5% or less

 It is strongly recommended that the battery must be charged as remaining capacity reaches to 10 % (1 bar). If not, there occurs the splice loss.

4.2 Turn on the Swift KR12A

Press  and hold for about 1.0 second without opening the windshield cover. The initial screen is displayed as below after resetting all their initial functions. It is important to choose a right splice and heat mode to ensure an accurate splicing result. The current splice and heat mode are displayed at the bottom of the initial page.



4.3 Installing the sleeve loader / cooling tray

Get the sleeve loader installed as follows.





Install the cooling tray on the rear side of heater as follows.



4.4 Cleaning the fiber

Clean carefully the fiber with a piece of soft cloth or gauze soaked in alcohol. Dust on the fiber coating surface may increase attenuation and cause the fiber break after the heating of sleeve.

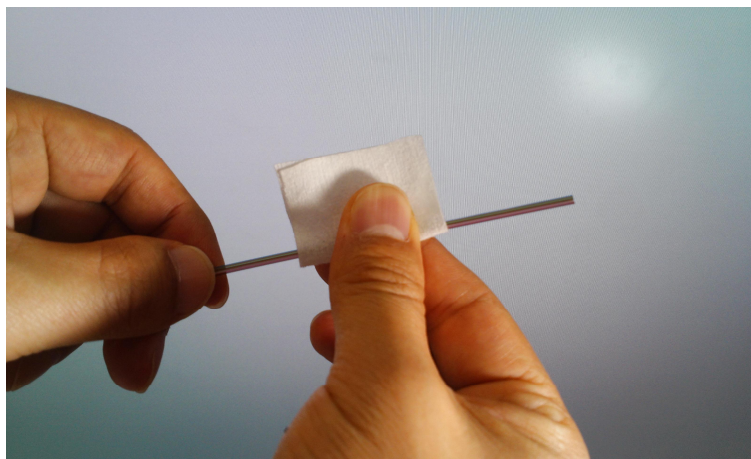

4.5 Inserting the fiber into the sleeve

Insert the fiber into the sleeve.

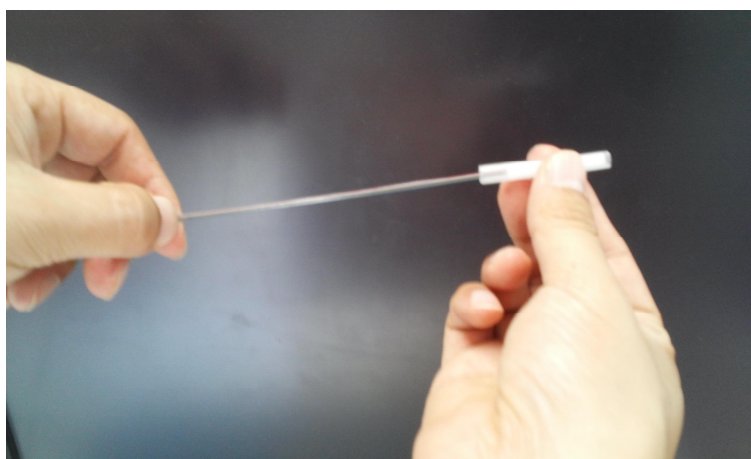

4.6 Placing the fiber into the holder and stripping

Place the fiber on the fiber holder as shown below. In the case of ribbon fiber, the color of each fiber should be matched each other left and right.

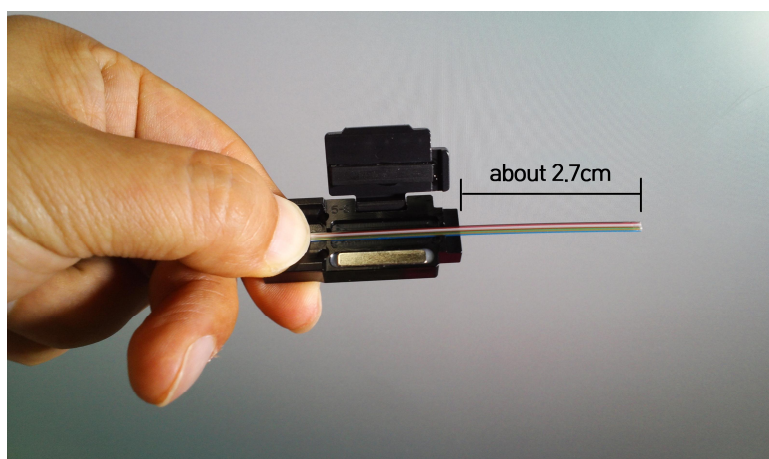

Clean carefully the fiber with a piece of soft cloth or gauze soaked in alcohol.

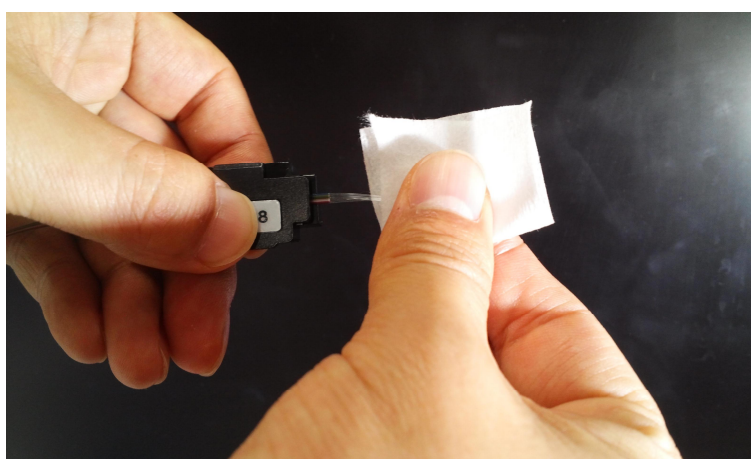

⚠ Use high quality ethyl-alcohol with higher than 96% purity.

4.7 Cleaving the fiber

- i. Place the stripped fiber on the V-groove of the cleaver and check the length to cleave the fiber. Separate the each fiber when using the ribbon fiber. If the each fiber is not separated, it can make the problem on the cleaving.

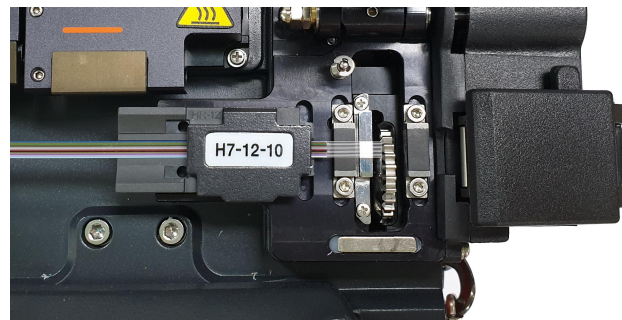

- ii. Pull down and press the cover to cleave the fiber.
- iii. Lift the cover and take out the cleaved optical fiber.
- iv. Remove the fiber fragments and dispose it in a proper container.

 Please read user manual of the cleaver for more detailed information about the operation of the cleaver.

4.8 Load the fiber to the Swift KR12A

- i. Open the windshield cover. Insert the fiber holder on the Swift KR12A.

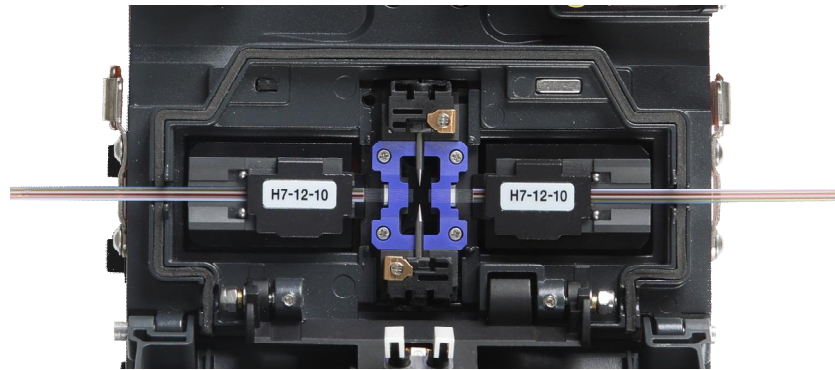

- ii. Make sure that the tip of the prepared fiber does not contact other object.
- iii. Place the other fiber in the same way as directed above.
- iv. Close the windshield cover carefully.

 To reduce align time; place the fiber properly.

Place the each fiber on the V-Groove property when using the ribbon fiber.

4.9 Splice

The condition of the fiber can be observed via the image processing system in the Swift KR12A. However, the visual inspection is necessary to ensure better splice result. The splicing process starts as soon as the windshields cover is closed in Auto mode.

- i. The fibers loaded in the splicer move toward each other.
The movement stops at the positions after the fiber cleaning arc. Then the splicer checks cleaved angle, end-face quality and dust. If the measured cleaved angle is bigger than the preset limit value or any damage of the fiber is discovered, an error message appears on the screen and the splice process stops. Though no error message appears on the screen, visual inspection on cross section is recommended as the process stops.
- ii. After inspection, the both fibers are aligned clad to clad.
The measured values of cleaved angle and off-set can be displayed on the screen.
- iii. After completion of the fiber alignment, arc discharge is performed to splice the fibers.
- iv. The estimated loss value is measured after splicing and displayed on the screen. The estimated loss value is affected by various error related elements. And, these elements also influence the estimation and computation of the value. The computation of the loss value is based on measurement factor. If the estimated loss value is greater than the preset limit, an error message appears on the screen. Also, an alarm can be triggered by the discovery of an abnormal condition of the spliced part including too thick or thin area or bubbles. Even if an error message does not occur, it is recommended to perform the arc fusion process again if the result on the screen does not look good enough.

4.10 Removing the spliced fiber

- i. Open the sleeve heater cover.
- ii. Open the windshield cover.
- iii. Hold the left-fiber holder and open the cover of the right-fiber holder.
- iv. Open the cover of the left-fiber holder.
- v. Hold the both sides of the spliced fiber and remove the fiber from the Swift KR12A carefully not to break.

4.11 Heating the sleeve

- i. Move the center of sleeve to the splice point. Make sure the strength member in the sleeve is downward.
- ii. Put the sleeve to the center of the sleeve heater.
- iii. Apply tension to the fiber downward so that the sleeve heater cover is closed automatically.
- iv. Press  to start sleeve heating.
- v. The LED is turned off when sleeve heating is completed.
- vi. Open the heater cover and remove the fiber. Do not touch the sleeve and heater part immediately after heating.
- vii. Check to ensure there is no bubble, fragments or dust in the sleeve at all times.



V. Maintenance

5.1 Cleaning and examination prior to splicing

5.1.1 Cleaning V-Groove

Any contaminants inside the V-groove will affect the splicing condition of the fiber, resulting in higher splice loss. Hence, it is important to inspect the V-groove often and clean it periodically in accordance with following ways.

- i. Open the windshield cover.
- ii. Clean the bottom of the V-Groove with a cotton swab soaked in alcohol. Remove the remaining alcohol inside the V-groove with a clean and dry cotton swab.
- iii. If the foreign substances contaminants inside the V-groove are not removed by the cotton swab soaked in alcohol, use the tip of the cleaved optical fiber. And then, repeat step 2 again.

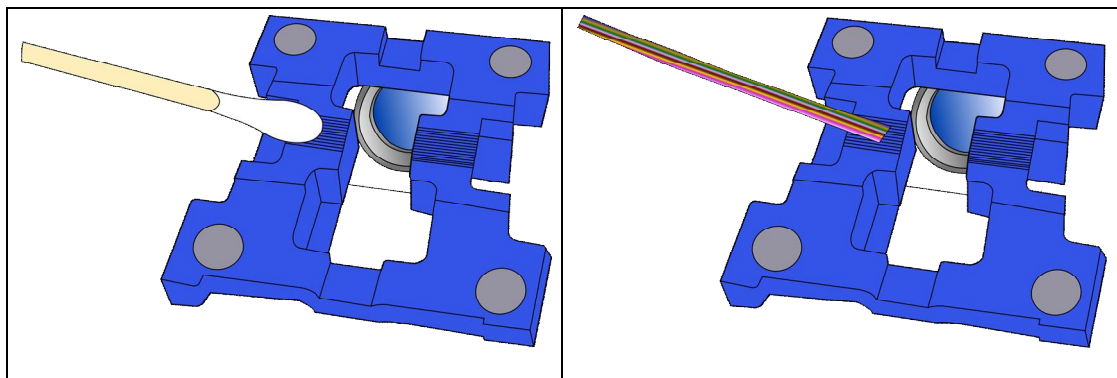

5.1.2 Cleaning the cleaver

The performance of the fiber cleaver can be deteriorated if the blade or clamp pads of the cleaver are contaminated. In addition, the contamination of the fiber surface or tip can cause higher splice loss. For this reason, it is important to clean both the blade and clamp pads of the cleaver with a cotton swab soaked in alcohol.

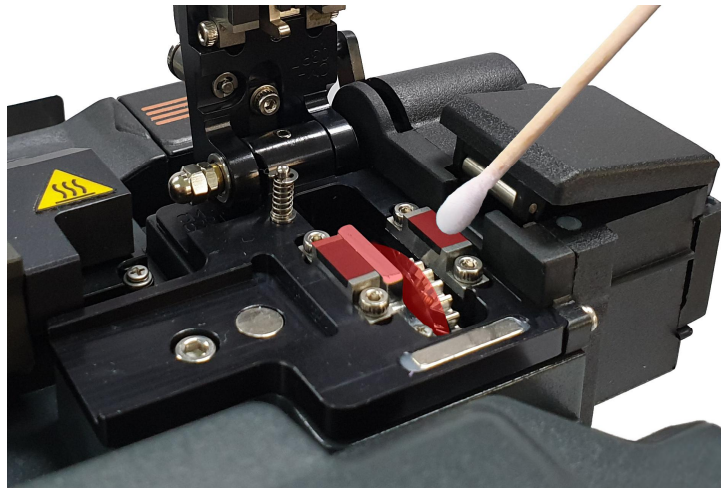

5.2 Regular maintenance and cleaning

It is crucial to perform inspection and cleaning on a regular basis to maintain the splice quality of the Swift KR12A.

5.2.1 Cleaning the objective lenses

The contamination of the objective lenses surface may cause inaccurate observation of the fiber position, resulting in higher splice loss and poor performance of the Swift KR12A. Therefore, the two objective lenses have to be cleaned on a regular basis. Otherwise, the dust sticks on the surface and it may become irremovable eventually. Clean them as instructed below.

- i. Turn off the power of the Swift KR12A prior to cleaning the lenses.
- ii. Remove electrodes.
- iii. The lens in a circular motion from the center with an alcohol-soaked soft cotton swab as below picture. Remove remaining alcohol on the surface of the lenses with dry and clean cotton swab.

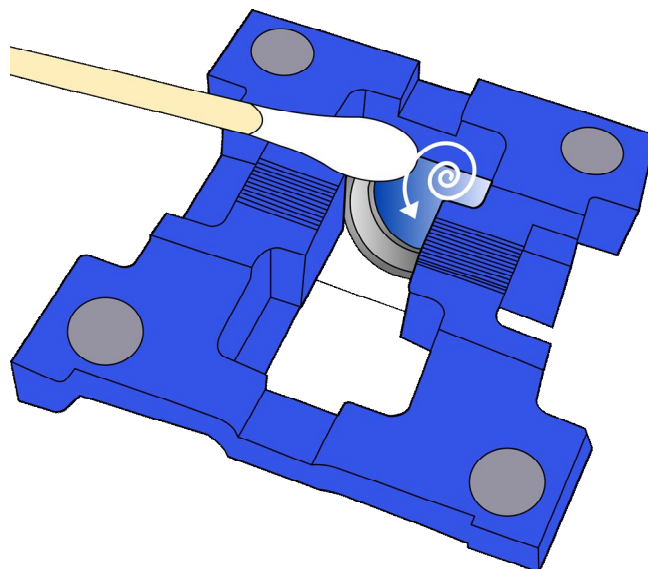

- iv. Check to ensure there is no line, scratch or stain.
- v. Re-assemble electrodes correctly.
- vi. Turn on the power and perform a diagnostic test.

5.2.2 Blade replacement and blade mode (Rotating / Locking)

Blade change

If the cleaver does not properly cleave the fiber, rotate the blade as follow the instructions. On the blade gear, the channel (cleaving position) from 1 to 24 is marked. When it does not cleave the fiber properly, clean the surface of rubber pad with the alcohol-soaked cotton swab. (But when clean the rubber pad, do not use acetone or solvent.) And if cleaver still does not cleave properly, it means the blade is fully used, operators are required to change the cleaving position by the following order.

[Blade Replacement]

- i. In order to replace blade, disassemble chip collector assembly and rear pusher. Open the cover as shown picture and press the pusher pin to move slider to forward.

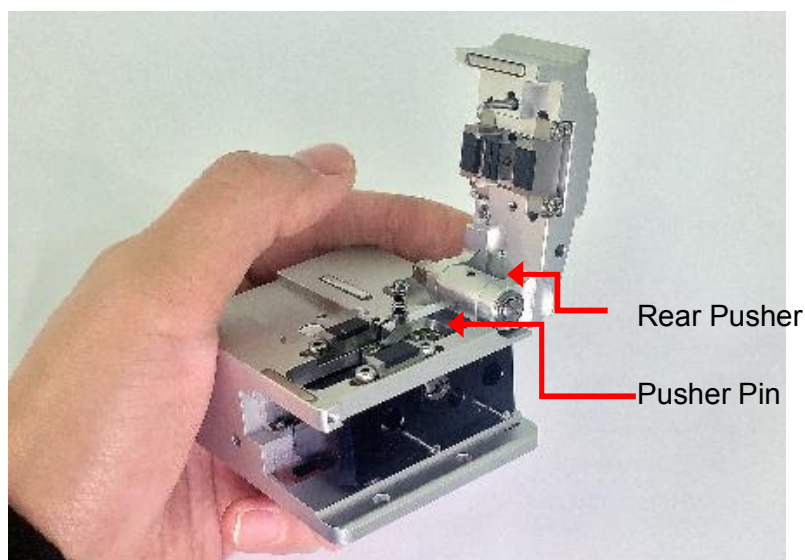

- ii. Remove blade pin completely using (-) driver.

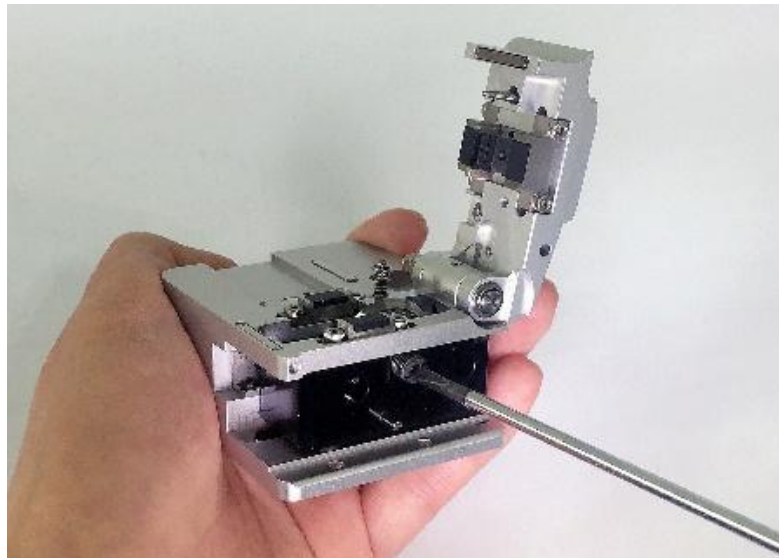

- iii. Remove old blade with blade gear from body and replace new blade with blade gear. In here reassembling should be done in a reverse order of disassembling. At this time, especially be careful not to damage the blade. Check the blade operating condition with cleaver cover.

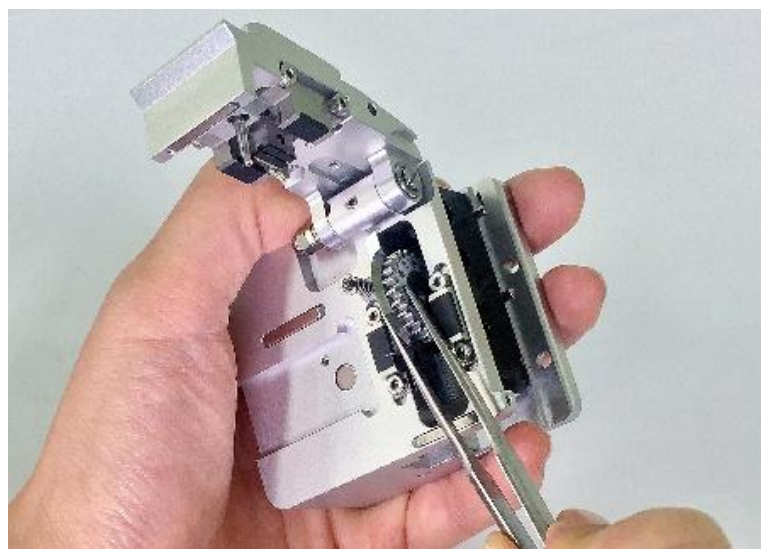

[Blade Mode (Rotating / Locking) Change]

- i. Blade rotating mode.

Initial setting mode will be set as shown picture (Rotation mode).

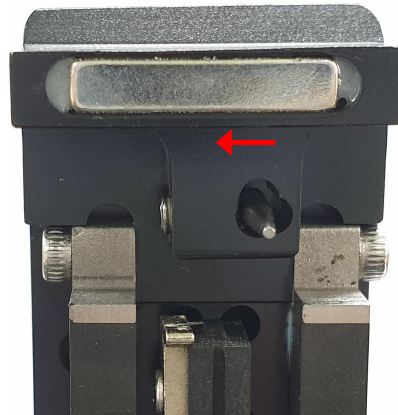

- ii. Adjust gear pusher position after loosen Set-screw as shown picture.

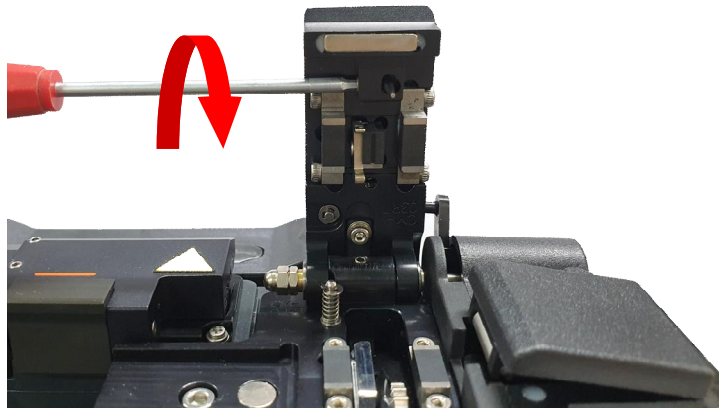

- iii. Blade locking mode.

When the blade is used without rotating.

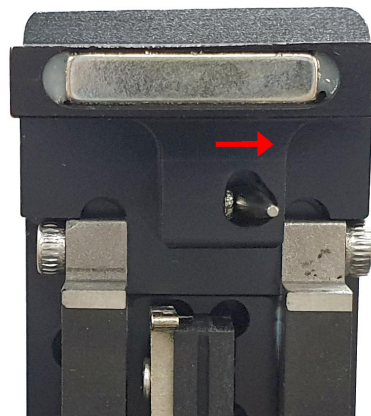

5.2.3 Electrodes Replacement

The recommended replacement cycle of an electrode is 3,000 times. If the real arc count exceeds the replacement cycle, a message for electrodes replacement appears. Without replacing the worn electrode, the splice loss increases and the spliced point becomes weaker.

- i. Turn off the splicer power.
- ii. Open the electrode block and unscrew the bolt.

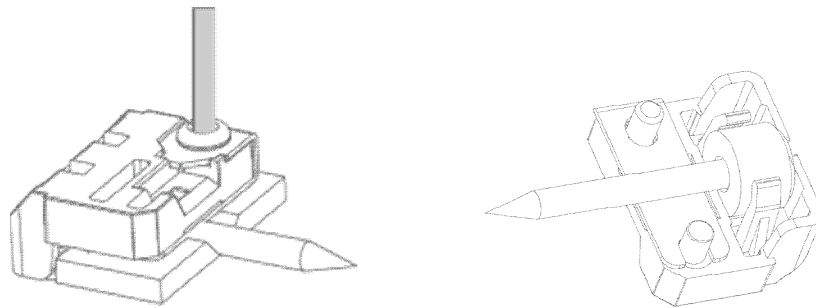

- iii. Remove the electrode block and take out the used electrode.
- iv. Carefully clean the new electrodes with a cotton swab soaked in alcohol and install them.
- v. Turn on the power. Perform the stabilization of the electrode by running the [Electrode Stabilize] menu.

VI. Menu

There are 9 sub menus in the main menu. To call a main menu, press . It can be clicked the screen. The main menu is as below.

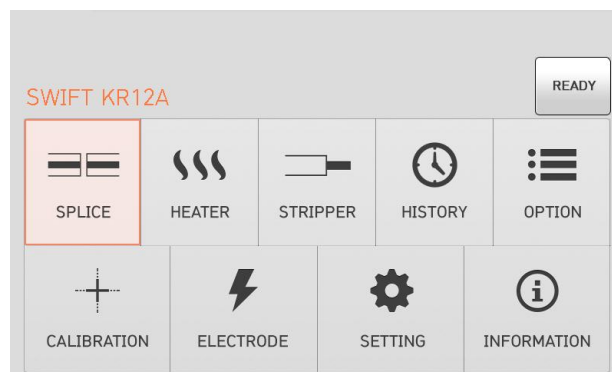

■ Splice

- ✓ Del: delete splice mode.
- ✓ Replace: select a splice mode from database, replace it.
- ✓ New: add a new mode from database.
- ✓ Edit: edit a splice parameters.
- ✓ Select: select a splice mode for operation.
- ✓ Close: close menu window.

■ Heat

- ✓ Del: delete heat mode.
- ✓ Replace: select a heat mode from database, replace it.
- ✓ New: add a new mode from database.
- ✓ Edit: edit a heater parameters.
- ✓ Select: select a heat mode for operation.
- ✓ Close: close menu window.

■ Auto Stripper

- ✓ Del: delete Stripper mode.
- ✓ Replace: select a Stripper mode from database, replace it.
- ✓ New: add a new mode from database.
- ✓ Edit: edit a Stripper parameters.
- ✓ Select: select a Stripper mode for operation.
- ✓ Close: close menu window.

■ History

- ✓ Display memory: display a splicing data and image.
- ✓ Clear Memory: erase the whole data.

■ Option

- ✓ Default: Auto, Pause, Auto Heater
- ✓ Lock: Splice Lock, Heat Lock, Clear memory Lock, Password Query
- ✓ Password: change a password.

■ Calibration

- ✓ Arc Calibration: calibrate an arc power.
- ✓ Diagnostic Test: test an state of the Swift KR12A.
- ✓ Dust Test: test a dust in optical path.
- ✓ LED Test: test a LED brightness.
- ✓ Motor Drive: drive a motor manually.

■ Electrode

- ✓ Electrode Caution: set a caution message for replacement
- ✓ Electrode Used: display an arc count number.
- ✓ Electrode Replace: display an warning message.
- ✓ Electrode Stabilize: stabilize an arc discharge current.
- ✓ Clear Arc Count: erase an arc count number.

■ Setting

- ✓ Language: select a language.
- ✓ Date: set a current time.
- ✓ Power Save: set a sleep function of the Swift KR12A.
- ✓ Buzzer: change a buzzer volume.
- ✓ LCD Brightness: change a monitor brightness.

■ Information

- ✓ Maintenance Info: display a date for maintenance.
- ✓ Sensor Value: display a temperature, pressure and humidity.
- ✓ Program Ver: display the version.
- ✓ Help: display the help contents as below.
 - The names of parts
 - Clean and Inspect
 - Warnings
 - A/S Contact List

POP-UP Menu

The pop-up menu is new feature of the Swift KR12A. The purpose of the pop-up menu is to allow quick access to frequently used modes like splice mode and heat mode. The user can access the pop-up menu in various ways.

[How to call a POP-UP Menu]

- i. Press "Set" for splice pop-up menu in the initial state or click left-lower corner.

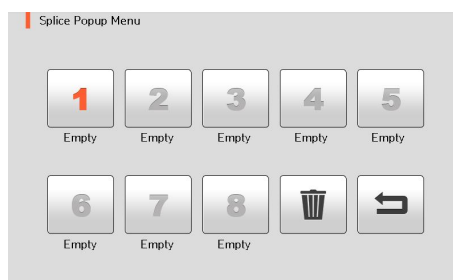

- ii. Press "Heat" for heat pop-up menu in the initial state or right-lower corner.



- iii. Click Left-upper corner.



- Menu: same function with
- Set: same function with
- Heat: same function with
- Auto Stripper: same function with

[Splice POP-UP Menu]

■ How to add

- i. Press "Set" for splice pop-up menu in the initial state.

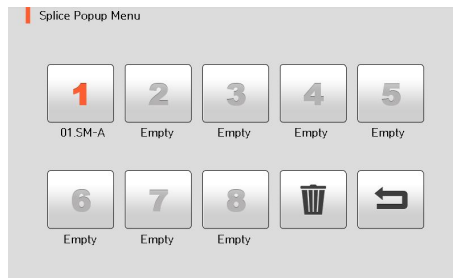

- ii. Select Empty slot.

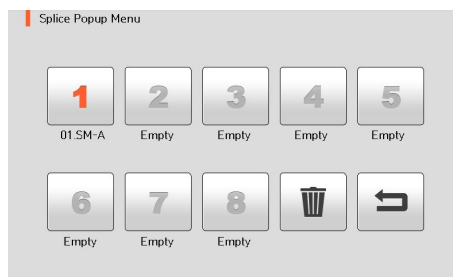

- iii. Select the splice mode.

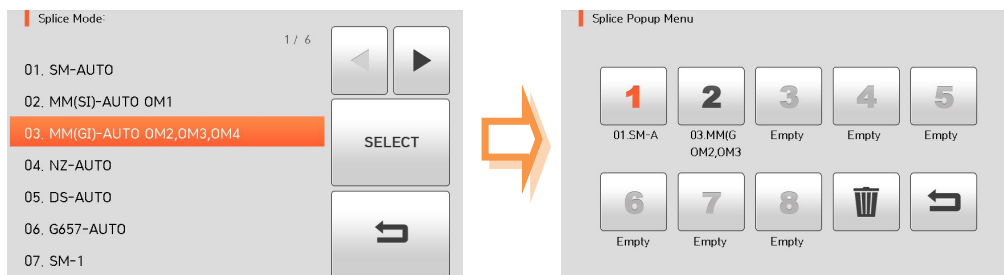

■ How to delete

- i. Click .

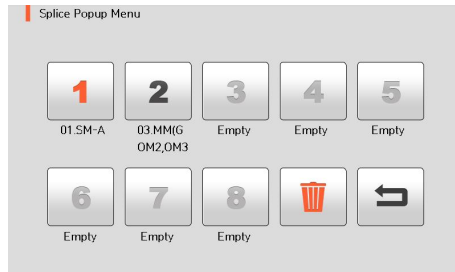

- ii. Select mode to be deleted.

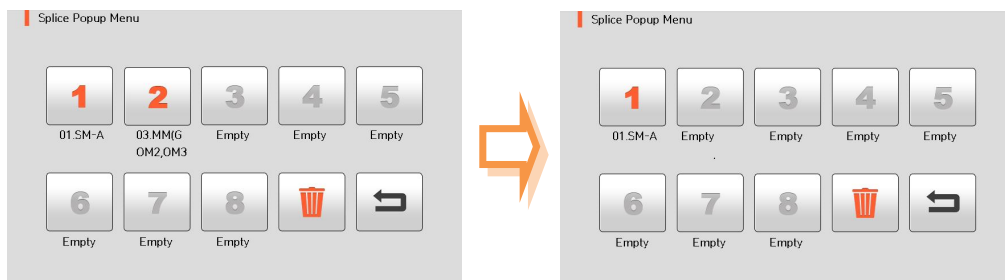

[Heat POP-UP menu]

■ How to add

- i. Press "Heat" for heat pop-up menu in the initial state.

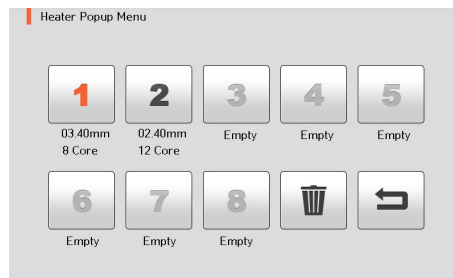

- ii. Select Empty slot.



- iii. Select the heat mode.

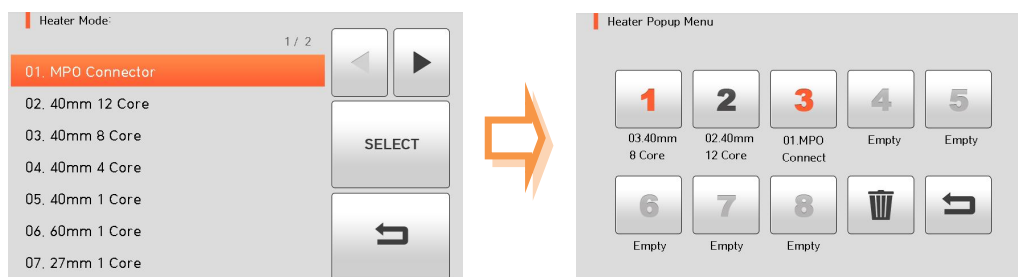

■ How to delete

- i. Click .

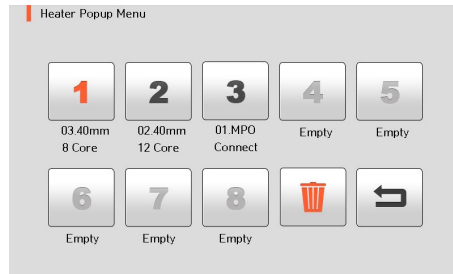

- ii. Select mode to be deleted.

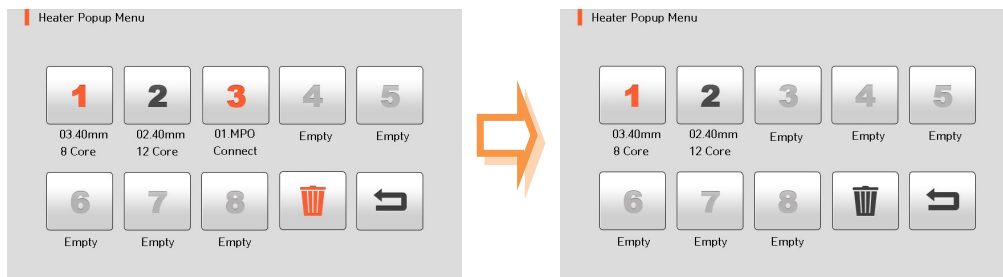

6.1 Splice

In normal operation mode, to call the splice menu, press . Then you can see the splice menu as below. There're already various splice modes and whatever the user can select for easy operation. Also the splice mode will be stored up to 100. The splice mode is classified as a normal mode and a user mode.

- Normal splice mode: mode number 1 to 42
- User splice mode: mode number 43 to 100

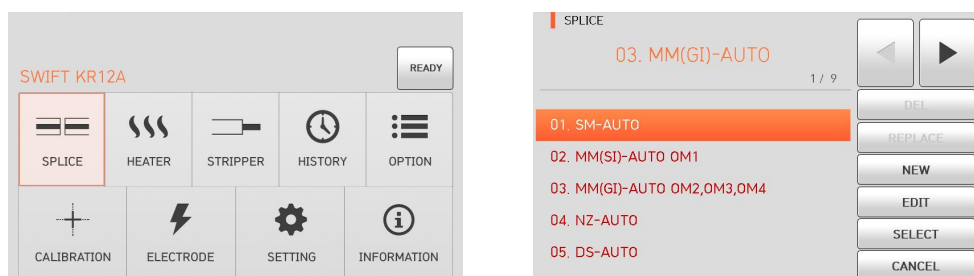

[Summary of Splice Mode]

Splice mode	Description
AUTO	The Swift KR12A identifies the number of fibers automatically. Users are not allowed adjusting arc discharge amount. AUTO mode consists of SM AUTO, MM AUTO, NZ AUTO, DS AUTO, G657 AUTO.
SM-1 ~SM-12	For splicing basic single mode fibers. MFD is 9~10um at the wavelength of 1310nm.
NZ-1 ~NZ-12	For splicing NZDS fibers. MFD is 9~10um at the wavelength of 1550nm. WDM fibers can be spliced in this mode as well.

DS-1 ~DS-12	For splicing DS fibers. MFD is 7~9um at near 1550nm.
MM-1 ~MM-12	For splicing multi-mode fibers. Core diameter : 50.0 ~ 62.5um
G657-1 ~G657-12	For splicing G.657A1 fibers G.657A1 is improved bending loss than basic SMF(G.652D) MFD is 9~10um at near 1550nm.
Other	Other splice modes are saved in the Swift KR12A database. New splice modes will be continuously added to the database. Please contact UCLSWIFT Co., Ltd for the latest available splice modes.

6.1.1 Del

Firstly select the splice mode; click "Del", the selected splice mode is deleted.
The splice mode from No.1 to No.42 can't be deleted.

6.1.2 Replace

Click "Replace", then the splice modes stored in memory is displayed on the screen.
Select the splice mode to be replace, click "OK". The selected splice mode replaces the last blank mode.

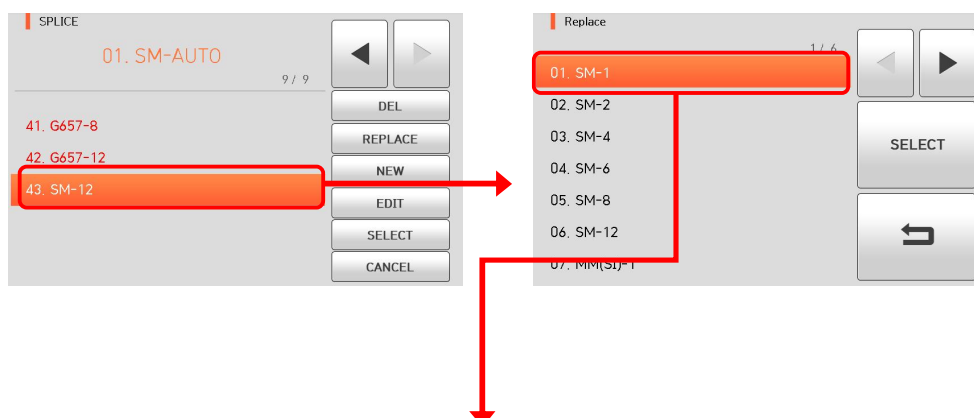

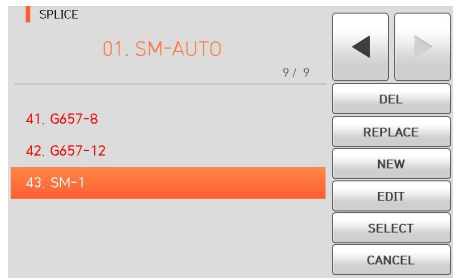

The splice mode from No.1 to No.42 can't be replaced.

6.1.3 New

Click "New", then the splice modes stored in memory is displayed on the screen. Select the splice mode, click "OK". The selected splice mode is added the last blank mode.

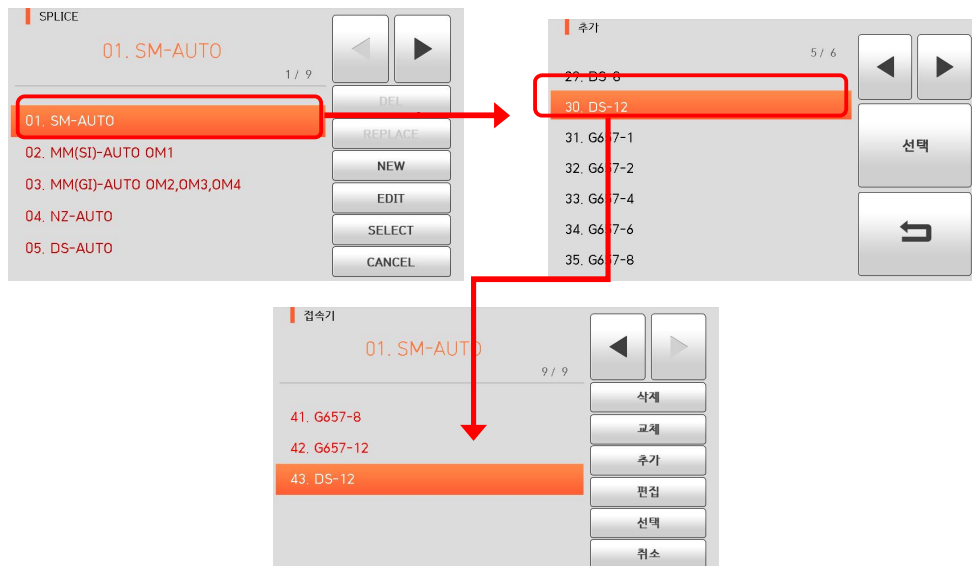

The splice mode from No.1 to No.42 can't be added.

6.1.4 Edit

Click "Edit", then the splice parameters is displayed on the screen. Select parameters, adjust it for proper operation.

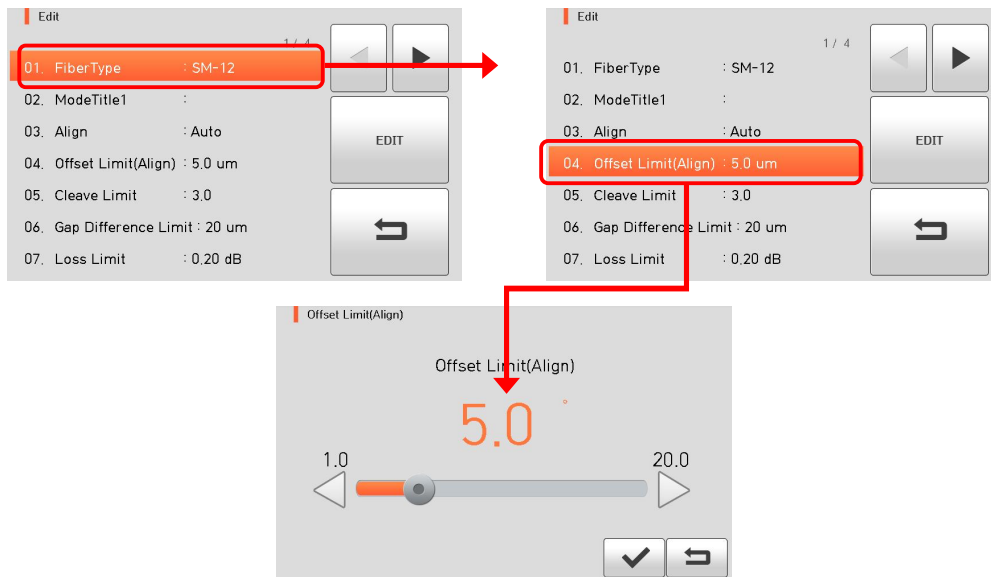

The splice mode from No.1 to No.42 can't be edited.

[Editable parameters in mode]

Parameters	Description	Normal mode	User mode
Fiber type	The splice modes saved in the database are displayed. The mode selected by the user is copied to the splice mode in the user side program.	Non Editable	Editable
Mode title 1	The title can be composed of 1 to 11 characters.		
Mode title 2	It consists of up to 11 characters and is used to provide more detailed information. It can be found in the [Splice Mode] menu.		
Align	It is used to set the fiber arrangement methods.		
	“Auto”: Fibers are aligned to the center position automatically.		
	“Manual”: Fibers are aligned directly with motor control.		
Offset Limit (Align)	It sets the offset range of each fiber when aligning the fibers.		
Cleave Limit	It sets the tolerance range of cleave angle. An error message appears when a measured right, left or both angles exceed the range.		
Gap Difference Limit	It estimates the gaps of the corresponding fibers.		
	An error message appears when the deviation of the gap is greater than the maximum range.		
Loss Limit	It sets the error range of estimated loss.		
	An error message appears when the estimated loss is greater than the maximum range.		

Proof test	If [Proof Test] is set to "ON", a test is carried out during the opening the windshield after splicing or pressing RESET.	Non Editable	Editable
Cleaning Power	A short period of arc discharge is performed to remove the fine dust on the fiber surface as setting the distance between the cross sections of the fibers.		
Cleaning Time	The duration of arc discharge is set.		
Gap	It sets the distance between the left fiber and right fiber.		
Gap set Pos.	It sets the position of the fibers to the center of arc discharge.		
Prefuse Power	It is set by the prefuse power from the beginning of arc to the moment before the fibers start moving forward. At this moment, if the initial value is too low, the axis' offset can occur due to bad cross section angle of the fiber. On the other hand, if the initial value is too high, the fiber can be burned out or shaped round, resulting in aggravating the splice loss.		
Prefuse Time	It is set by the prefuse time beginning of arc to the moment before the fibers start moving forward. The meaning of [long Prefuse time] indicates greater [Prefuse power].		
Overlap	It sets the duplication amount of the fiber from the forward amount. If [prefuse power] is weak or [prefuse time] is not long enough, the [overlap] needs to be smaller. On the other hand, it should be set to bigger if the arc is strong or the time is longer.		

Arc1 Power	The arc can be adjusted by two steps. The first step is [arc1] and second is [arc2]. [arc1] is set here.	Non Editable	Editable
Arc1 Time	It sets the time of [arc1].		
Arc2 Power	It is the second step of arc. [arc2] is set here.		
Arc2 Time	It sets the time of [arc2]. In general, [arc2 time] is set to "OFF". It is possible to set a very long arc time; however, if the [arc1 time] and [arc2 time] is longer than 30 seconds, the electrode can be damaged.		
Arc2 On-Time	It sets arc to ON and OFF alternatively while the [arc2] is performing arc discharge. The duration of [arc2] operating time is set here. Arc discharge time ON has to be set always in order to conduct re-arc.		
Arc2 Off-Time	It is used to set the duration of [arc2] non-operating time. When the [arc2] stops working, the re-arc stops as well. Set this parameter to "OFF" if a continuous re-arc is required.		
Re-arc Time	It sets the re-arc time.		
	It automatically sets the re-arc to discharge the same amount as [Arc 2] in [Splice Mode Edit]. If arc 2 is set to ON and OFF, the re-arc is automatically set to ON and OFF as well.		
Taper Splice	The splice loss rate increases sometimes when the fiber becomes thinner. The taper splice is set to "OFF". The attraction is decided by following three parameters.		
Taper Wait	It sets the time between the last moment of fiber's moving forward and the initiation of attraction.		

Taper speed	It sets the speed of the fiber attraction.		
Taper Length	It sets the time of attraction.		
Offset	It refers to the sum of the initially measured splice loss value and increased loss value. When splicing special types of the fiber or different kinds of the fiber, a higher splice loss can occur even under an optimized arc discharge condition. The minimum value of the actual splice loss has to be set in order to accord the actual splice loss value with estimated splice loss value.		

6.1.5 Select

Click "Select", then the selected splice mode is stored in the memory for operation.

6.1.6 Close

Click "Close" to go to the previous menu.

6.2 Heat

In normal operation mode, to call the heat menu, press . Then you can see the heat menu as below. There're already various heat mode and the user can select for proper operation. Also the heat mode will be stored up to 100. Please note that the user can't use the Del and Replace keys and use Edit key partially from mode No 1 to No 8.

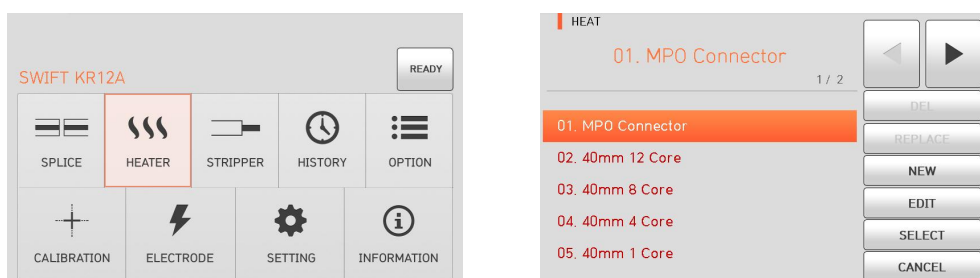

[Summary of Heat Mode]

Parameters	Parameters	Remark
R-F40	2 core~12core 40mm Ribbon fiber Sleeve	Non editable for Sleeve Type, Mode title1,2
60mm	Standard 60mm Sleeve for 0.9mm fiber	
40mm	Standard 40mm Sleeve for 0.9mm fiber	
Micro	Micro Sleeve for 0.25mm fiber	

6.2.1 Del

Firstly select a heat mode; click "del", the selected heat mode is deleted.

The mode from No 1 to 8 can't be deleted.

6.2.2 Replace

Click “Replace”, then heat modes stored in memory are displayed on the screen. Select a heat mode, click “OK”. The selected heat mode replaces the last blank mode.

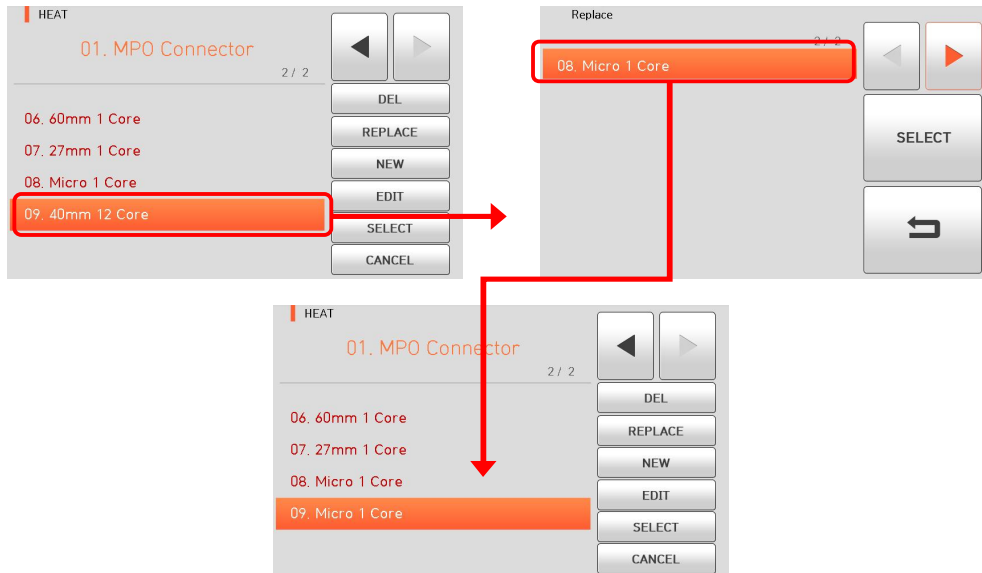

The mode from No 1 to 8 can't be replaced.

6.2.3 New

Click “New”, then heat modes stored in memory is displayed on the screen. Select a heat mode, click “OK”. The selected heat mode is added the last blank mode.

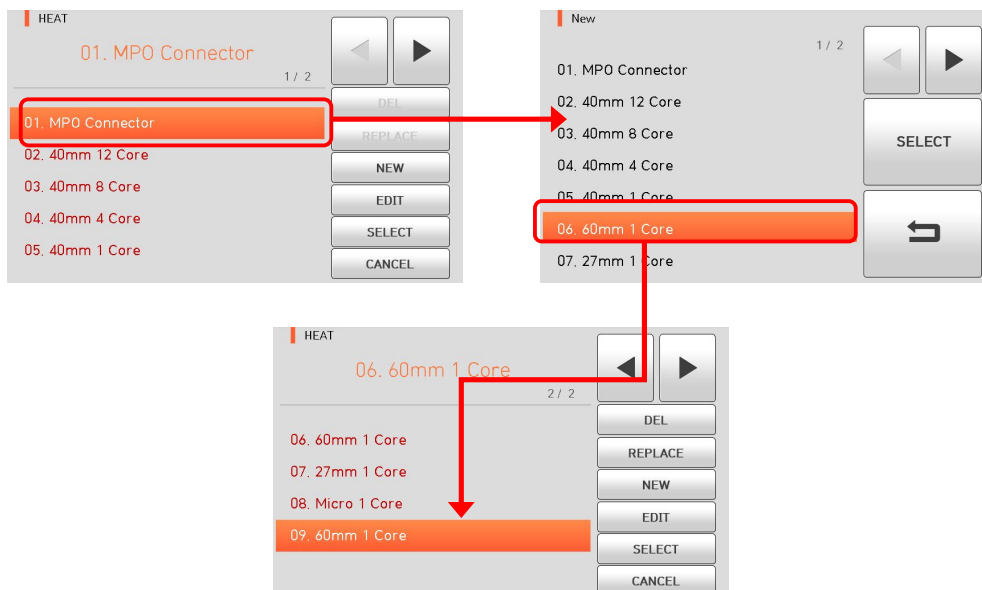



The mode from No 1 to 8 can't be added.

6.2.4 Edit

Click “Edit”, then heat conditions stored in memory are displayed on the screen. Select parameters, adjust it for proper operation.

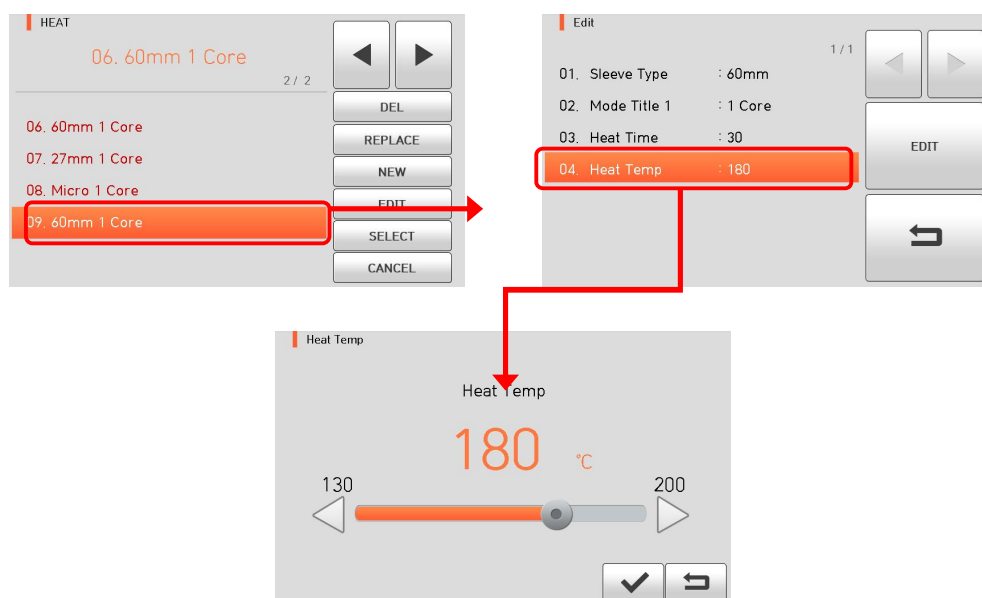

The heat mode from No.1 to 8 can't be edited.

6.2.5 Select

Click “Select”, then the selected heat mode is stored in the memory for operation.

6.2.6 Close

Click “Close” to go to the previous menu.

6.3 Auto Stripper menu

In normal operation mode, to call the Stripper mode, press **MENU**. There're already various Stripper mode and the user can select for proper operation. Also the heat mode will be stored up to 100. Please note that the user can't use the Del and Replace keys and use Edit key partially from mode No 1 to No 13.

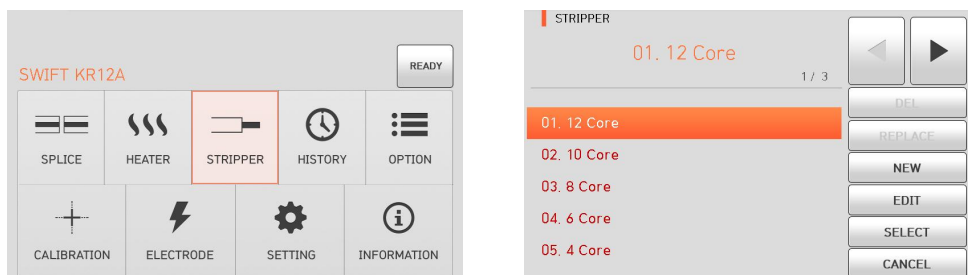

6.3.1 Del

Firstly select the Stripper mode; click "del", the selected heat mode is deleted. The mode from No 1 to 13 can't be deleted.

6.3.2 Replace

Click "Replace", then Stripper mode stored in memory are displayed on the screen. Select the Stripper mode, click "OK". The selected Stripper mode replaces the last blank mode.

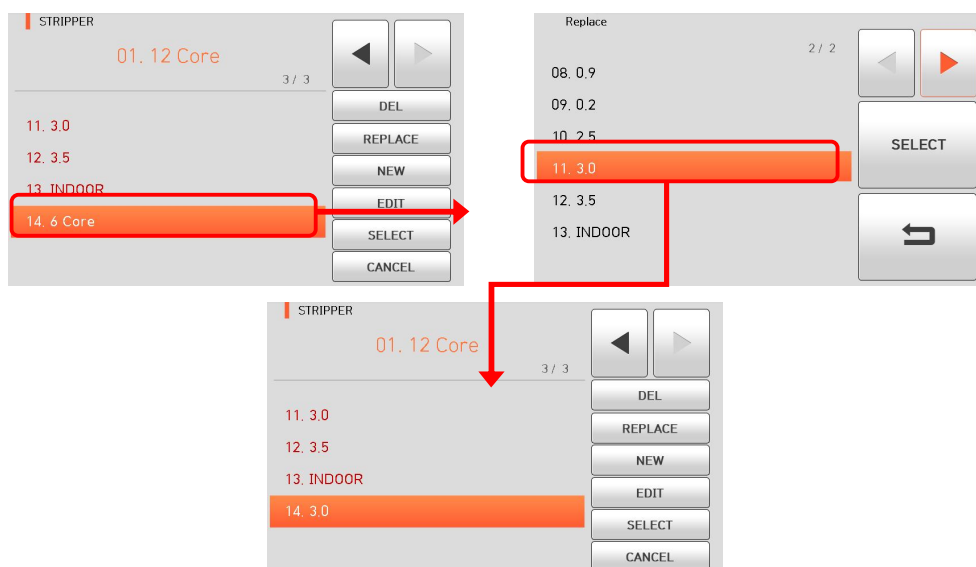

The mode from No 1 to 13 can't be replaced.

6.3.3 New

Click "New", then Stripper mode stored in memory is displayed on the screen. Select the Stripper mode, click "OK". The selected Stripper mode is added the last blank mode.

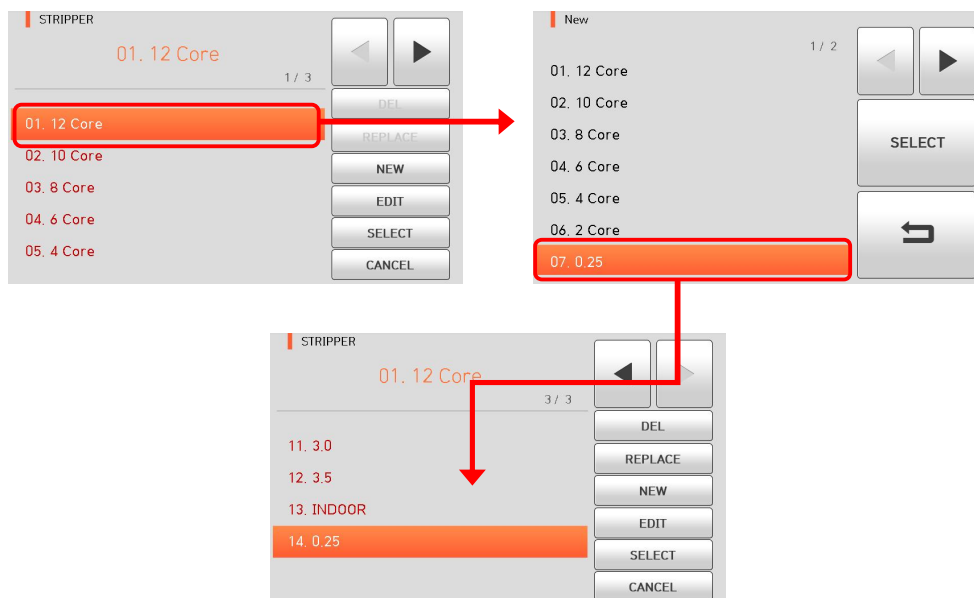

The mode from No 1 to 13 can't be added.

6.3.4 Edit

Click "Edit", then Stripper mode conditions stored in memory are displayed on the screen. Select parameters, adjust it for proper operation.

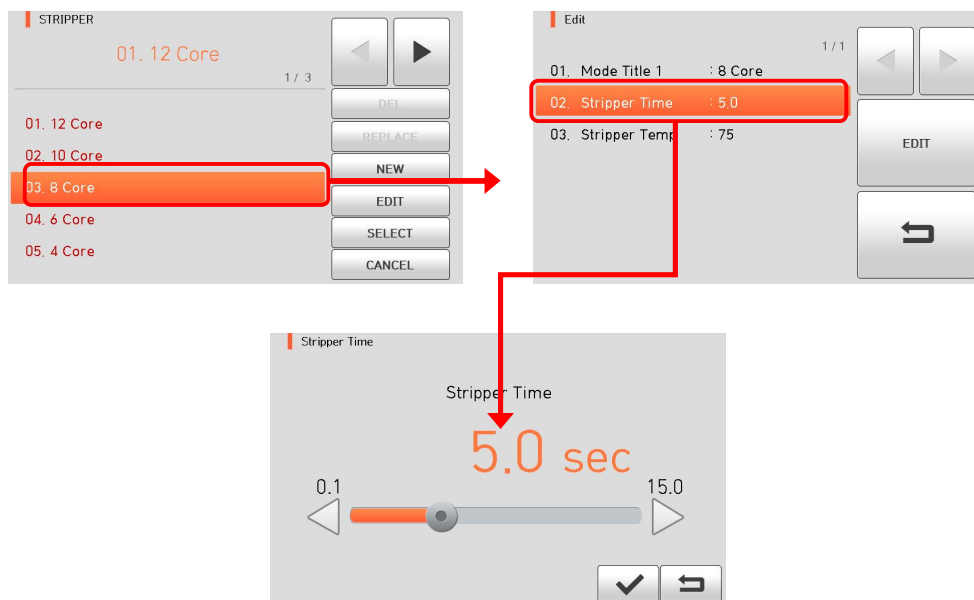

The Stripper mode from No.1 to 13 can't be edited.

6.3.5 Select

Click "Select", then the selected Stripper mode is stored in the memory for operation.

6.3.6 Close

Click "Close" to go to the previous menu.

6.4 History

In normal operation mode, to call the history menu, press . Then you can see the history menu as below. There're already various functions to display data and image also copy such data to USB memory.

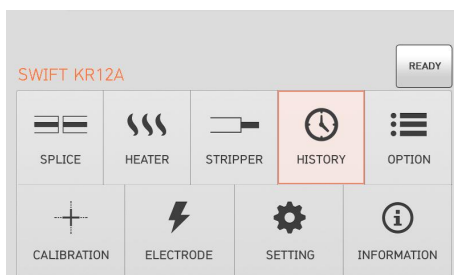

6.4.1 Display Memory

The 10,000 both splice loss data and image can be stored and the user can see them. Each page has 500 loss data and splice image, click “ ” to move the page. After choosing a data with scroll bar, click View to see.

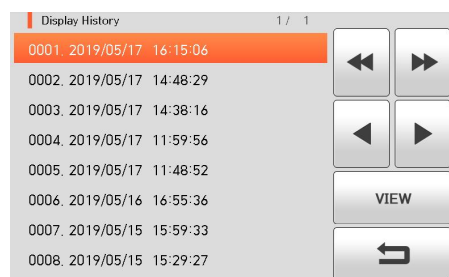
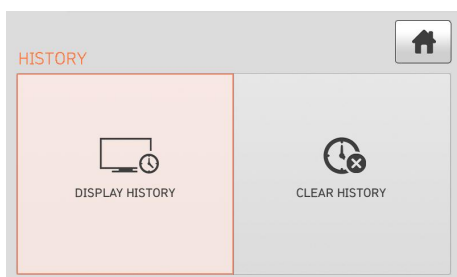

Display History		
	Loss	Error
1	0.01 dB	OK
2	0.02 dB	OK
3	0.02 dB	OK
4	0.00 dB	OK
5	0.02 dB	OK
6	0.00 dB	OK
7	0.00 dB	OK
8	0.01 dB	OK
9	0.00 dB	OK
10	0.01 dB	OK
11	0.01 dB	OK
12	0.02 dB	OK

- 2019/05/17 16:15:06
- Fiber Type : SM-12
- Temperature : 34.0 °C
- Pressure : 1006 hpa
- Cleave Limit : 3.0 °
- Loss Limit : 0.20 dB
- Arc Power : 220 bit
- Image : X

6.4.2 Clear memory

Clear memory erases the whole data.



6.5 Option

In normal operation mode, to call the option menu, press **MENU**. Then you can see the option menu as below. There're already various functions and whatever the user can select for proper operation.

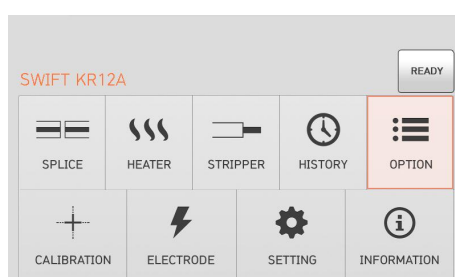

6.5.1 Default

Default is composed of 3 sub check boxes. To activate a Default menu, check a check box.



Parameters	Description
Auto splice	Do splice process automatically.
Pause	Stop the process after the preset position, press SET for next.
Auto Heat	Power on sleeve heater automatically after splicing process.

6.5.2 Lock

Default is composed of 4 sub check boxes. To activate a Default menu, check a check box. Also it is possible to limit the modifications with respect to the total splice mode, heat mode, and internal memory data by setting up a password. You have to remember the password. If you forget the password, the device has to be brought to the UCLSWIFT Co., Ltd to fix it.

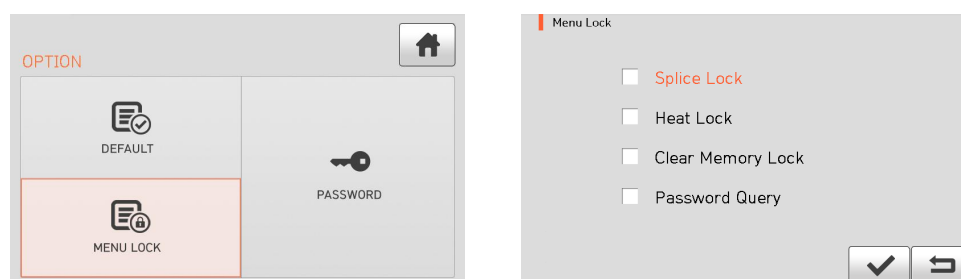

	Test item	Description
1	Splice Lock	Lock the modification of the splice mode.
2	Heat Lock	Lock the modification of the heat mode.
3	Clear memory Lock	Lock the modification of the memory.
4	Password Query	To call a password window The initial password is "1234".

6.5.3 Password

Set up a new password as follow.

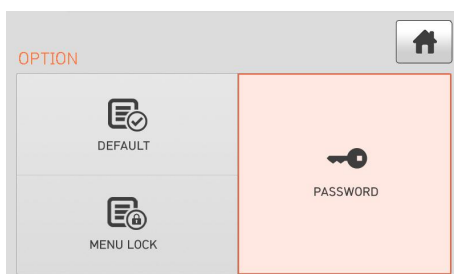

- i. Enter a current password.
The initial password is "1234".



- ii. Enter a new password.



- iii. Confirm a new password.



- If an incorrect password is entered or you press a wrong button, the screen moves to upper level.

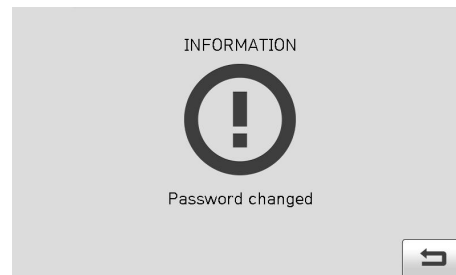
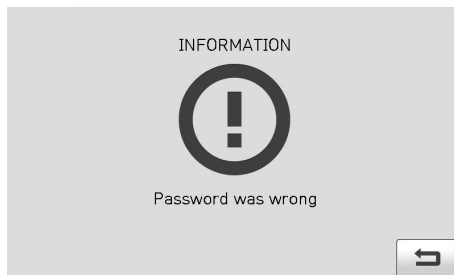

- You have to remember the password. If you forget the password, the device has to be brought to UCLSWIFT Co., Ltd to fix it.

6.6 Calibration

In normal operation mode, to call the calibration menu, press . Then you can see the calibration menu as below. There're already various functions to arc test, diagnostic test and motor drive test.

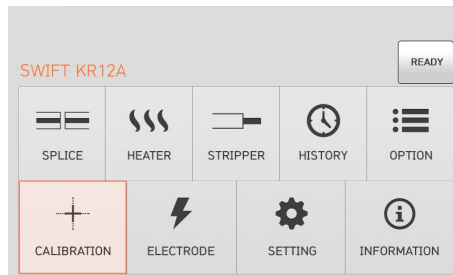

6.6.1 Diagnostic Test

Diagnostic test executes various types of tests at a time. It is executed in the order Dust Test, LED Check.

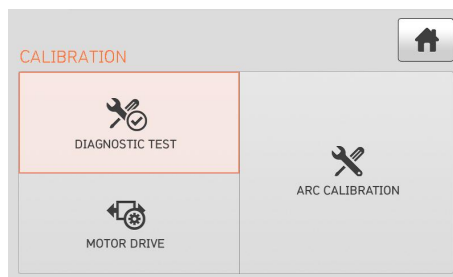





	Test item	Description
1	Dust Test	Refer on Dust Test, without fiber.
2	LED Test	Refer on LED Check, without fiber.

6.6.2 Motor Drive

It checks the operating status of the motor manually.



- i. Place the fiber in the splicer.
- ii. Click “Motor Drive”.
- iii. To select a motor. The name of the selected motor is displayed at the top left on the screen.
- iv. Use   to move the selected motor to a desired direction.

Motor		
ZL/ZR	ZL/ZR Move forward.	ZL/ZR Move backward.
S	Move step by step press a button.	
M	Move while pressing a button.	

6.6.3 Arc Calibration

The arc calibration is; the variation of temperature, humidity and air pressure has been detected by internal sensors continuously. Based on such a variation, supply a feedback data into the monitoring system to adjust an arc power a constant level. Additionally the changes in arc power due to the abrasion of the electrode and glass adhesion are not automatically calibrated. Also, the center axis of arc discharge may be moved to left or right. Thus the fiber splicing position is not matched to arc discharge center. For this reason, Arc calibration is required.

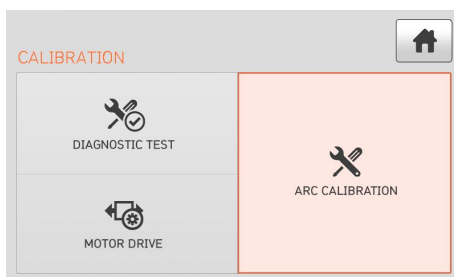

- Arc calibration is a function to change the value of arc discharge voltage. It is used for the computation program for splicing. In addition, the calibration value of arc discharge cannot be changed in the splice mode.
- For the purpose of Arc calibration, 12 core or 8 core single mode fibers are used.

- i. Place the SM fiber to splicer.
- ii. Click "OK".

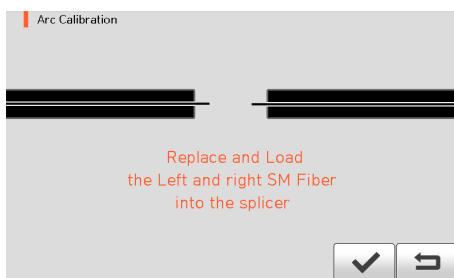

- iii. Result similar to following is displayed on the screen when measuring is completed.

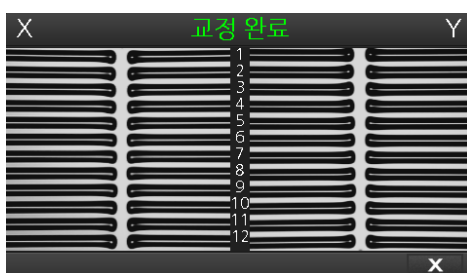

- iv. The calibration can be stopped by pressing **RESET** even if it has not completed.

⚠ The tip of the fiber should be removed after [arc calibration].

Otherwise, it may cause serious damage to the stripper blade.

6.7 Electrode

In normal operation mode, to call the Electrode menu, press . Then you can see the Electrode menu as below. It is necessary to regularly check and clean the electrodes because they are worn out. The silica oxidized substances is deposited as the electrodes go through numerous times of splices. There're already various functions to arc count, replace time and other.

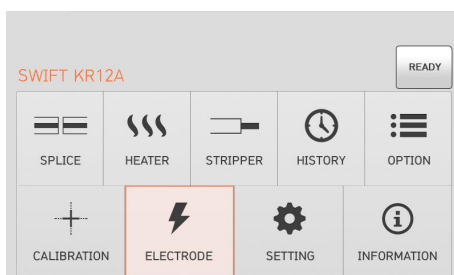

6.7.1 Electrode Stabilize

Sometimes, surrounding environment may cause the occurrence of irregular arc discharge or splice loss increase. In particular, since it takes a while until discharge is stabilized when the splicer is in lower or higher location, you have to keep adjusting the discharge until the electrodes are stabilized. Especially after installing new set of electrodes, the user must do Electrode Stabilize as follows.

- i. Place the fiber in the arc fusion splicer.
- ii. Click "Electrode Stabilize".

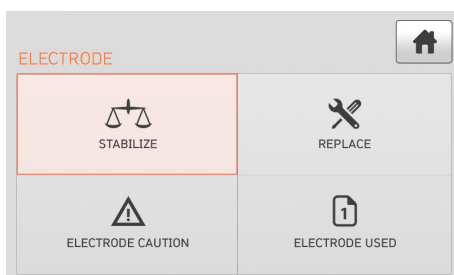

- iii. Click

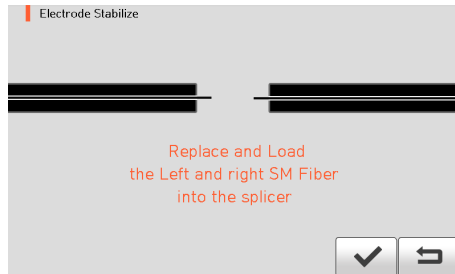

- iv. Perform 30 cycle continuous arc discharge to stabilize the electrodes.
- v. Result similar to following is displayed on the screen when measuring is completed.

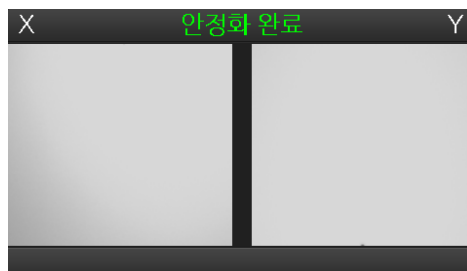

- vi. After completing the Electrode Stabilize, ARC Calibration should be performed separately.

6.7.2 Electrode Replace

The recommended replacement cycle of an electrode is 3,000 times use. When the set cycle completes, a message to replace the electrode appears.

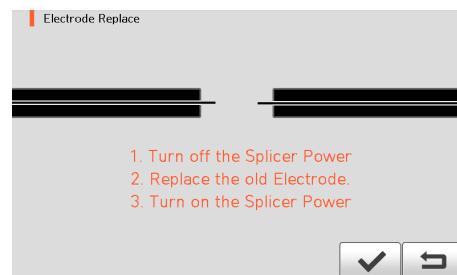
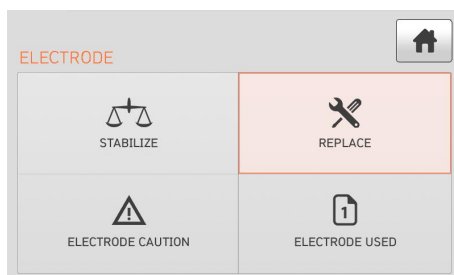

6.7.3 Electrode Caution

It determines the arc count for alert message. The recommended replacement cycle of an electrode is 3,000 times use.

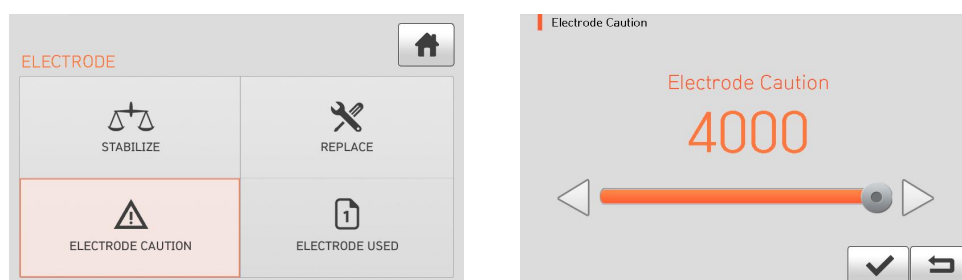

6.7.4 Electrode Used

It displays the used arc count.

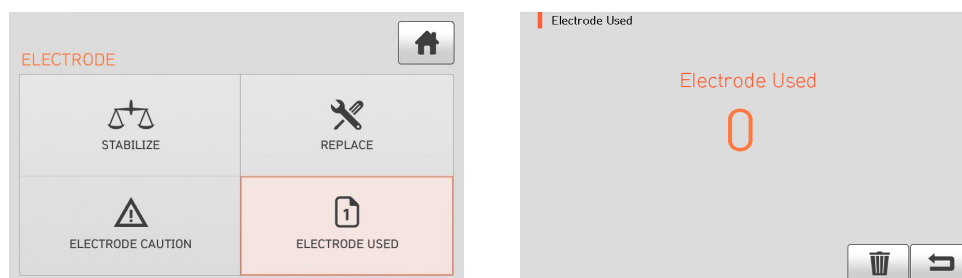

6.7.4.1 Clear Arc Count

It erases the number of arc count. When insert new set of electrodes, please reset arc count.

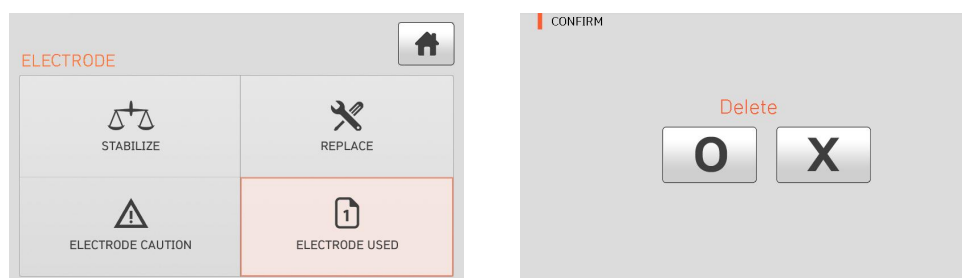

6.8 Setting

In normal operation mode, to call the Setting menu, press . Then you can see the Setting menu as below.

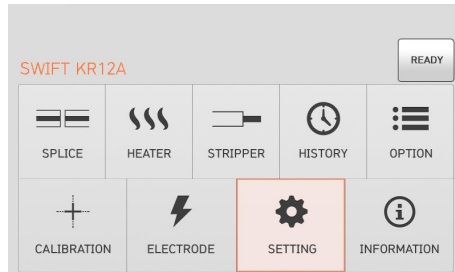

6.8.1 Language

It sets a language to be displayed on the screen.

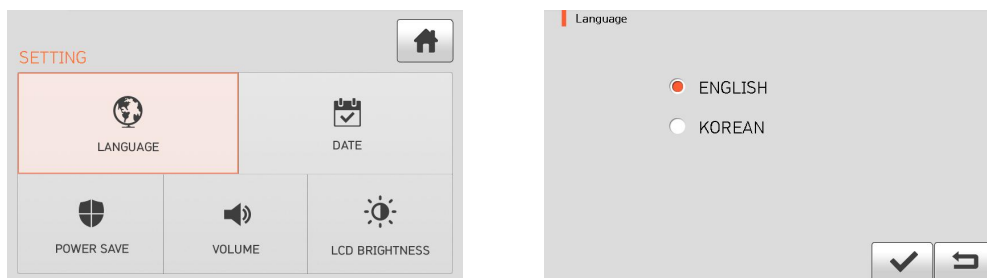

6.8.2 Date

It sets the date and time in the calendar.

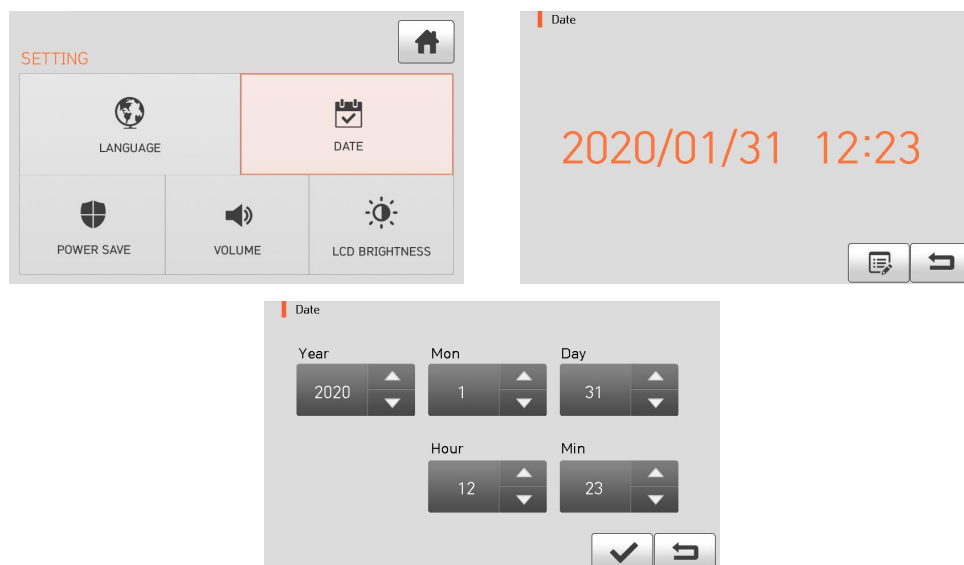

6.8.3 Power Save

It is an important function in terms of energy efficiency. When the Swift KR12A operates with a battery, we recommend activate this function to increase your working time.

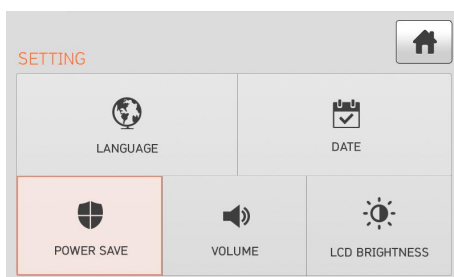

6.8.3.1 Monitor

The LCD will be automatically turned off, if you don't operate the Swift KR12A for a setting time. The monitor is turned on again when you press any button.

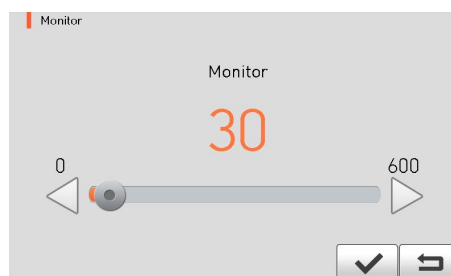
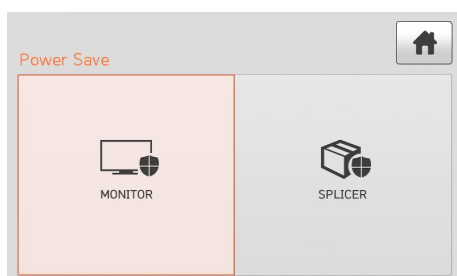

6.8.3.2 Splicer

The Swift KR12A will be automatically turned off, if you don't operate it for a time set.

The Swift KR12A is turned on again only when you press .

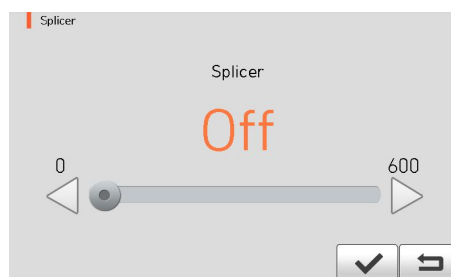
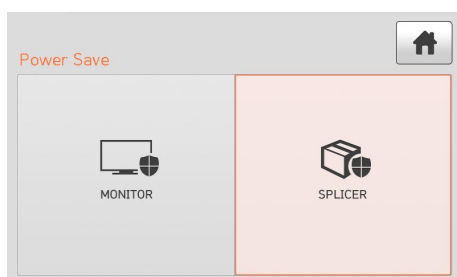

6.8.4 Buzzer

To adjust the buzzer volume.

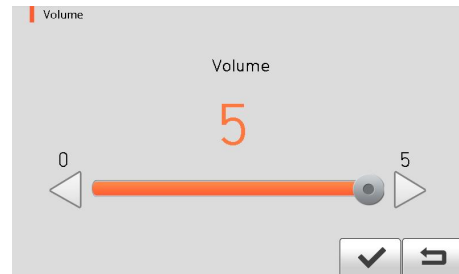
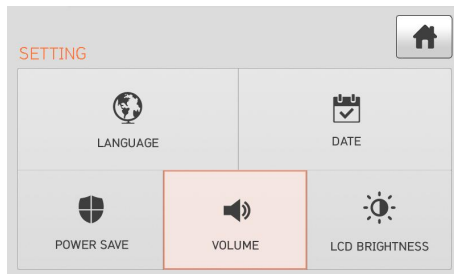

6.8.5 LCD Brightness

To adjust a monitor brightness.

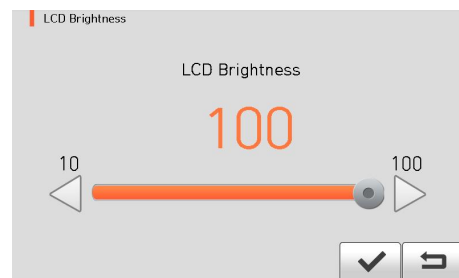
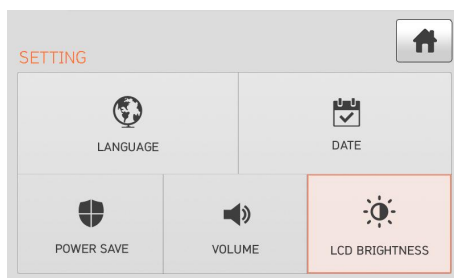

6.9 Information

In normal operation mode, to call the Information menu, press . Then you can see the Information menu as below. There is some information for your maintenance.

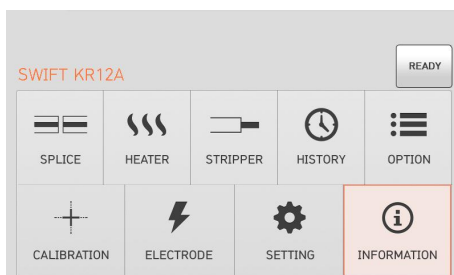

6.9.1 Maintenance Info

Click "Maintenance Info", following information is displayed.

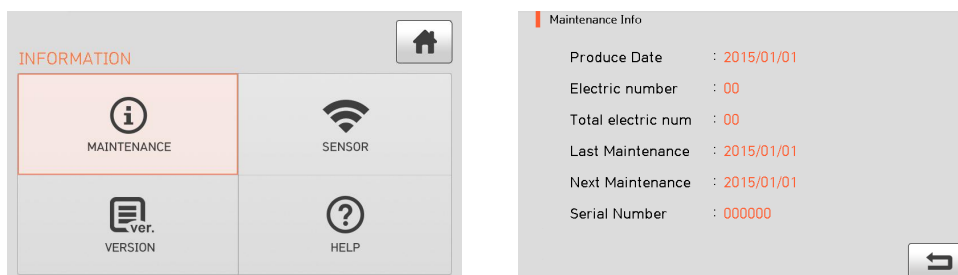

Item	Description
Produce date	The date when equipment was manufactured (year, month and date).
Electric number	Arc discharge count since the replacement of the electrode.
Total electric number	Total arc discharge count since its first operation.
Last maintenance	The date when the device was maintained most recently.
Next maintenance	The date when the device will be maintained next time.
Serial number	The unique serial number given to the device.

6.9.2 Sensor Value

Click “Sensor Value”, following information is displayed.

The splicer consists of various sensors including temperature, pressure and humidity.

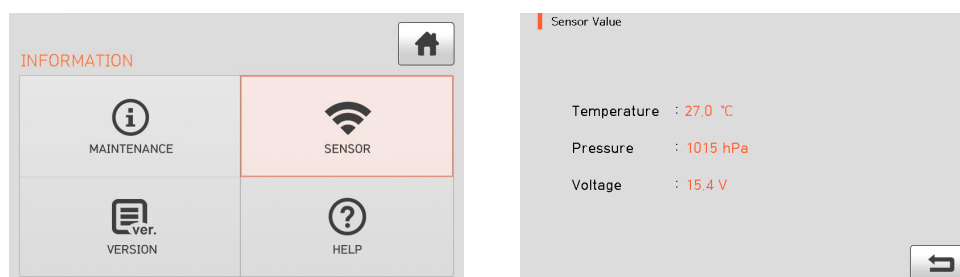

6.9.3 Program Ver

Click “Program Ver”, following information is displayed.

The firmware is upgraded using USB memory.

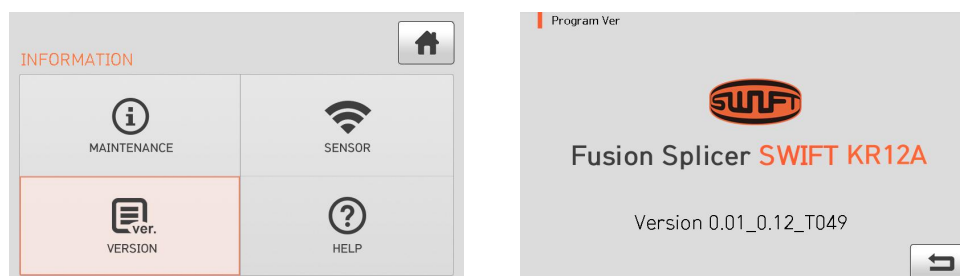

6.9.4 HELP

Click "HELP", following help is displayed.

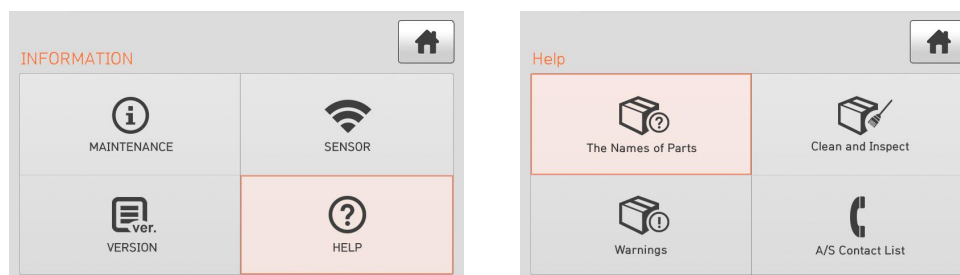

Item	Description
The Name of Parts	The main part of the Swift KR12A
Clean and Inspect	How to clean and inspect
Warnings	Warnings
A/S Contact List	Service contact point

VII. Error message

7.1 Too Dirty Fiber

It is displayed when the fiber prepared for splice is contaminated more than normal status.

How to: Reset the fiber after cleaning.



7.2 Replace The Fiber In The Correct Position

It is displayed when the fiber is not placed in the middle of the electrodes and V-groove or the objective lenses or reflection mirror is contaminated.

How to: Press **RESET** and place the fiber in the middle of the electrodes and V-groove.

How to: Check the condition of the lenses and reflection mirror and remove any dirt.

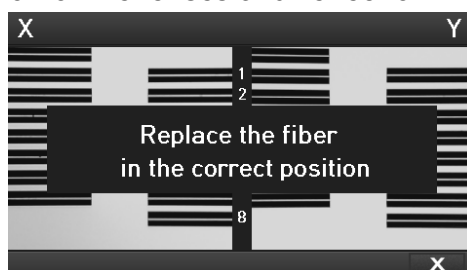

7.3 Too Long Fiber

It is displayed when the fiber is placed too close to the electrode, the lenses or reflection mirror is dirty or LED light is not bright enough.

How to: Press **RESET** and place the fiber again.

How to: Remove dust and dirt from the lenses and reflection mirror.

How to: Conduct an LED test. If an error occurs, contact UCLSWIFT Co., Ltd.



7.4 Fiber Over Angle

It is displayed when the measured cleaving angle of the fiber is greater than the limit.

How to: Reset the fiber after checking the condition of the cleaver.

How to: Check the value of the cleaving angle.

	Angle L	Angle R
1	1.1°	0.4°
2	0.3°	0.8°
3	0.4°	0.4°
4	0.8°	0.8°
5	0.4°	1.3°
6	0.3°	0.3°
7	0.4°	0.4°
8	1.1°	1.1°

7.5 Fiber Is Not Placed In V-Groove.

Please Place The Fiber Again.

It is displayed when the fiber is not placed on the V-Groove.
How to: Place the fiber again.

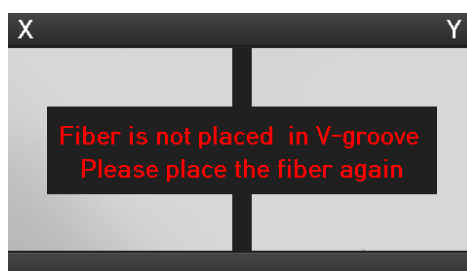

7.6 The Variation Of The Optical Fiber Core.

To Cut Back The Fiber.

It is displayed when the measured variation of the fiber length is greater than the limit.

How to: Reset the fiber after checking the condition of the cleaver.

How to: Check the value of the variation.

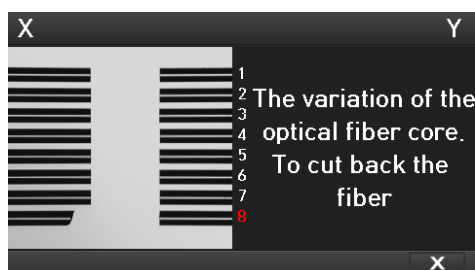

7.7 Mismatch Fiber Number

It is displayed when the number of fibers is not consistent with opposite side.

How to: Check all the fibers are placed on the V-Groove.

How to: Make sure broken fibers.

How to: Check the splice mode is being used properly.

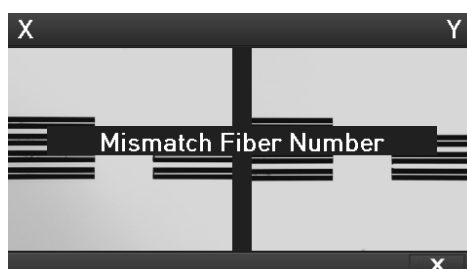

7.8 Core Bubble Error

It is displayed when bubbles or dots exist in the spliced part after completing the splice.

How to: Check the condition of the cleaver.

How to: Clean the V-groove.

How to: Check the condition of the electrode.

기포 발생		Loss
1	0.03 dB	
2	0.02 dB	
3	0.01 dB	
4	0.01 dB	
5	0.04 dB	
6	0.04 dB	
7	0.01 dB	
8	0.04 dB	
9	0.04 dB	
10	0.04 dB	
11	-- dB	
12	0.03 dB	

기포 발생		Error
1	Loss	
2	Loss	
3		
4		
5	Loss	
6	Loss	
7		
8	Loss	
9	Loss	
10	Loss	
11	Bubble	
12	Loss	

7.9 Gap Limit Over

It is displayed when the measured gap of the fiber is greater than the limit.

How to: Reset the fiber after checking the condition of the cleaver.

X		Gap Limit Over !!!	
		Gap	Offset
1		37 um	0 um
2		37 um	1 um
3		37 um	0 um
4		45 um	0 um
5		52 um	0 um
6		52 um	0 um
7		45 um	0 um
8		60 um	0 um
9		52 um	0 um
10		52 um	0 um
11		52 um	1 um
12		52 um	0 um

VIII. How to deal with splicing problems

8.1 When the splice loss is too high

- It may have been caused by dirt or dust on the surface of fibers.
 - Carefully clean the surface of the fibers.
 - DO NOT clean the fiber after being cleaved so as to prevent the contamination of its cross section.

- The arrangement of the fibers can be interrupted by the dirt in the V-groove.
 - Keep the V-Groove clean at all times.

- Bad electrodes
 - Replace the electrodes. The tips are bent or contaminated if they are worn out.

- Improper arc discharge or arc discharge time.
 - Check the set values of arc discharge amount and arc discharge time and reset them, if necessary.
 - The machine is delivered after being set to the most optimized values from the factory.

- Inappropriate splice mode
 - Check if the proper splice mode for the fiber has been selected.

8.2 Abnormal operation of arc fusion splicer

- The alignment motion is repeated.
 - Open and close the windshield cover again.
 - Rest the system by pressing  when an error occurs by opening the windshield cover. Turn off the power and contact UCLSWIFT Co., Ltd.

- The error message of “Too Long Fiber” appears repeatedly.
 - Reset and turn off the power. Contact UCLSWIFT Co., Ltd.

IX. Q & A

9.1 Power

- Unable to turn off the power by pressing  .
 - Press the switch and hold it for about 1 second and release the button when the monitor is turned off.

- Unable to splice as number of times as the splicer normally does with the battery that has been fully charged.
 - If the power saving mode is not activated, the battery runs out quickly. Please refer to [Setting Menu] for more information. If the battery has not been used for a while, charge it again until it is charged fully.
 - Use a new battery if the current battery was used for a long period of times and its suggested lifetime is passed. Since the battery works based on chemical reactions, power generated decreases at a low temperature and, in particular, it runs out very quickly when the temperature is below zero. Also, the battery runs out fast when it is used at a high temperature because the power consumption increases. If you cannot charge the battery fully, do as instructed below.

- LED is not turned on while charging the battery.
 - Disconnect the AC power cord from the charger and connect the DC cord to the charging jack. Connect the AC power cord in 10 to 15 seconds. The LED of the battery is turned on red and charging begins.

- Nothing is displayed on the indicator of the battery.



- When the battery indicator provides wrong information.
 - Use the indicator information only for your information.

9.2 Splice

- When an error message appears on the screen.
 - Refer to the [Error message list] for detailed information.
- Irregular of higher splice loss.
 - Clean the V-groove, V-block, reflection mirror and objective lenses referring to [Maintenance]. Replace the electrode referring to [Maintenance].
 - If the fiber is twisted or bent, place the bent direction down. The splice loss will vary depending on the cleaving angle, arc discharge conditions and the contamination condition of fiber. If you cannot fix the higher splice loss problem after performing abovementioned methods, contact UCLSWIFT Co., Ltd. It is recommended to conduct a regular maintenance of the machine once per year to ensure good splice quality.
- Monitor is turned off suddenly.
 - Press any key and check [Monitor Power Save].
- The power of the splicer is turned off suddenly.
 - Turn on the splicer again and check [Splicer Power Save].
- Unable to change arc discharge amount and time.

- You cannot change arc amount and time in SM, NZ, MM or Auto mode. A proper arc discharge amount can be maintained in these modes by performing [Arc Calibration]. The Arc amount and time will set automatically to prevent from being changed in other mode.
- How to set pause.
 - Refer to [Option Menu].
- Difference between estimated splice loss and measured splice loss.
 - The estimated splice loss is just a result from computation so it has to be used for reference only.

9.3 Sleeve heater

- The sleeve heater does not give sufficient shrinkage.
 - Increase the duration of heating time. Refer to [Heat Menu] for more information.
- The sleeve heater is overheated.
 - Stop the operation of the heater by pressing . Turn off the power and contact UCLSWIFT Co., Ltd.
 - When the sleeve is not separated from the heating plate, use a cotton swab or a similar object to this to push or remove the sleeve.
- How to initialize the heating condition in the heat mode?
 - Refer to [Heat Menu] for more information.
- How to cancel the heating process?
 - You cannot cancel the heating process by pressing . Press  one more time to cancel it.

9.4 The others

- How to lock “Splice”, “Edit” or heat mode?
 - Refer to [Lock Menu] for more.

- Arc amount is not changed after performing [Arc Calibration].
 - Internal factors are calibrated. Arc discharge amount displayed on each splice mode is not changed. The calibration result affects entire splice modes.

- If you forget the password.
 - Contact UCLSWIFT Co., Ltd.

X. Warranty period and service

Limited Liability

UCLSWIFT warrants its products against defects in material and workmanship. Under normal use and service, every hardware portion of the products will be free from physical defects in material and workmanship during the warranty period, or the product will be repaired or replaced as determined solely by UCLSWIFT. Customers will be charged for the repair of the machine even if in-warranty period, if such defect or damage occurred as a result of

- i. Natural disaster(s),
- ii. Applying over-voltage
- iii. Customer's mishandling
- iv. Customer's misuse without following instructions or operation procedures provided by this user manual
- v. Expendables (including electrode)

10.1 Information required for repair

Before sending the splicer to us, it is necessary to contact UCLSWIFT Co., Ltd first.

- i. Write following information on a piece of paper and attach it to the machine.
- ii. (Name, Department, Company, Address, Phone number, Fax number and email address)
- iii. Serial number of the machine
- iv. The operation condition of the arc fusion splicer and error messages that has appeared by the time the machine is sent to UCLSWIFT Co., Ltd.

10.2 Transport

The Swift KR12A is high precision equipment, so it is required to transport after keeping it in a safe case to protect it from humidity, vibration and physical shock. In case of request for repair, it must be in the case along with its parts before its transport.

10.3 Repair

Any data saved in the memory including splice results and splice modes may be deleted as a result of repair.

Products Warranty

Name of product		SWIFT KR12A	
Production Number			
Date of purchase			
Customer	Name	Telephone	
	Address		

Limited Warranty

1. This product is manufactured under strict quality management and inspection processes.
2. UCLSWIFT Co., Ltd warrants this product against defective materials and workmanship for a period of one year from the date of purchase. However, this warranty does not cover a damage or failure caused by or attributable to a reason for Exclusion and Limitations even if the equipment is still under warranty.
3. This warranty card has to be presented when the product is repaired.
4. The arc fusion splicer is high precision equipment, so it is required to transport after keeping it in an exclusive carrier case to protect it from humidity, vibration and physical shock.

Exclusion and Limitations

This warranty will not cover a damage or failure and charges (repairing charge + part + travel expenses) will apply even if the equipment is still under warranty, if such damage or failure has occurred due to or when

1. Natural disaster.
2. Applying over-voltage.
3. Customer's mishandling.
4. Customer's misuse without following instructions or operation procedures provided by this user manual.
5. The stamped seal is broken or damaged.

❖ When you require maintenance or repair service, please contact the service center or the dealer you purchased the machine.